

STIHL

STIHL FS 360 C-M, 410 C-M, 460
C-M, 490 C-M

Instruction Manual



Contents

Guide to Using this Manual	2	Specifications	45
Safety Precautions and Working Techniques	2	Maintenance and Repairs	47
Approved Combinations of Cutting Attachment, Deflector, Limit Stop and Harness	13	Disposal	48
Mounting the Bike Handle	15	EC Declaration of Conformity	48
Adjusting the Throttle Cable	18	UKCA Declaration of Conformity	49
Mounting the Deflector	18		
Mounting the Cutting Attachment	19		
Fuel	24		
Fueling	25		
Fitting the Full Harness	26		
Balancing the Machine	27		
Starting / Stopping the Engine	27		
Transporting the Unit	30		
Operating Instructions	32		
Air filter	32		
M-Tronic	33		
Winter Operation	33		
Spark Plug	35		
Engine Running Behavior	36		
Storing the Machine	36		
Sharpening Metal Cutting Blades	37		
Maintaining the Mowing Head	37		
Inspection and Maintenance by User	39		
Inspections and Maintenance by Dealer	39		
Maintenance and Care	41		
Minimize Wear and Avoid Damage	43		
Main Parts	44		

Dear Customer,

Thank you for choosing a quality engineered STIHL product.

It has been built using modern production techniques and comprehensive quality assurance. Every effort has been made to ensure your satisfaction and trouble-free use of the product.

Please contact your dealer or our sales company if you have any queries concerning this product.

Your



Dr. Nikolas Stihl

STIHL

This instruction manual is protected by copyright. All rights reserved, especially the rights to reproduce, translate and process with electronic systems.

Guide to Using this Manual

Pictograms

The meanings of the pictograms attached to the machine are explained in this manual.

Depending on the model concerned, the following pictograms may be attached to your machine.



Fuel tank; fuel mixture of gasoline and engine oil

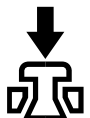

Operate decompression valve



Manual fuel pump

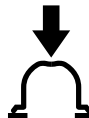

Operate manual fuel pump

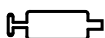

Tube of grease



Intake air: Summer operation



Intake air: Winter operation

Symbols in text



WARNING

Warning where there is a risk of an accident or personal injury or serious damage to property.



NOTICE

Caution where there is a risk of damaging the machine or its individual components.

Engineering improvements

STIHL's philosophy is to continually improve all of its products. For this reason we may modify the design, engineering and appearance of our products periodically.

Therefore, some changes, modifications and improvements may not be covered in this manual.

Safety Precautions and Working Techniques



Because the machine is a high-speed fast-cutting power tool, special safety precautions must be observed to reduce the risk of personal injury.



It is important that you read and understand the User Manual before commissioning and keep it in a safe place for future reference. Non-compliance with the User Manual may cause serious or even fatal injury.

Observe all applicable local safety regulations, e.g. by trade organizations, social insurance institutions, labor safety authorities etc.

If you have never used a power tool before: Have your dealer or other experienced user show you how to operate your machine – or attend a special course to learn how to operate it.

Minors should never be allowed to use the machine – except for apprentices over the age of 16 when working under supervision.

Children, animals and onlookers must remain at a safe distance.

When not using the machine, it must be laid down in such a way that it does not endanger anyone. Ensure that the machine cannot be used without authorization.

The user is responsible for accidents or risks involving third parties or their property.

Do not lend or rent your power tool without the User Manual. Be sure that anyone using it understands the information contained in this manual.

The use of machines that emit noise may be limited to certain hours of the day as specified by national and/or regional or local regulations.

Anyone operating the machine must be well rested, in good physical health and in good mental condition.

If you have any condition that might be aggravated by strenuous work, check with your doctor before operating a machine.

If you have a pacemaker: The ignition system of your machine produces an electromagnetic field of very low intensity. This field may interfere with some pacemakers. STIHL recommends that persons with pacemakers consult their physician and the pacemaker manufacturer to reduce any health risk.

Anyone who has consumed alcohol or drugs or medicines affecting their ability to react must not operate a power tool.

Depending on the cutting attachment fitted, use your power tool only for cutting grass, wild growth, shrubs, scrub, bushes, small diameter trees and similar materials.

The machine must not be used for any other purposes – **risk of accidents!**

Only use cutting attachments and accessories that are explicitly approved for this power tool model by STIHL or are technically identical. If you have any

questions in this respect, consult your dealer. Use only high-quality parts and accessories. In order to avoid the risk of accidents and damage to the machine.

STIHL recommends the use of genuine STIHL tools and accessories. They are specifically designed to match the product and meet your performance requirements.

Never attempt to modify your power tool in any way since this may increase the risk of personal injury. STIHL excludes all liability for personal injury and damage to property caused while using unauthorized attachments.

Do not use a high-pressure washer to clean the power tool. The solid jet of water may damage parts of the unit.

The guard provided with your machine may not protect the operator from all foreign objects (gravel, glass, wire etc.) ejected by the revolving cutting attachment. Ejected objects may also ricochet and strike the operator.

Clothing and equipment

Wear proper protective clothing and equipment.



Clothing must be robust but allow complete freedom of movement. Wear close-fitting clothes such as a boiler suit, not a loose jacket.

Do not wear clothing which could become trapped in wood, brush or moving parts of the machine. Do not

wear a scarf, necktie or jewelry. Tie up and confine long hair above your shoulders.



Wear safety boots with steel toe caps and non-slip soles.

Sturdy shoes with non-slip soles are permissible only when using mowing heads.



WARNING



To reduce the risk of eye injuries, wear close-fitting safety glasses in accordance with European Standard EN 166. Make sure the safety glasses are a snug fit.

Wear face protection and make sure it is a good fit. Face protection alone is not sufficient to protect the eyes.

Wear "personal" sound protection, e.g. ear defenders.

Wear a safety hard hat for thinning operations, when working in high scrub and where there is a danger of head injuries from falling objects.



Wear sturdy protective gloves made of a resistant material (e.g. leather).

STIHL can supply a comprehensive range of personal protective equipment.

Transporting the machine

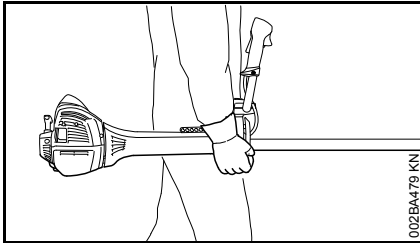

Always stop the engine.

Carry the machine hanging on the harness or by the shaft so that it is balanced. Fit transport guard on metal cutting attachments to avoid the risk of injury from blade contact



Avoid touching hot parts of the machine and gear-box – **risk of burns!**

By vehicle: When transporting in a vehicle, properly secure your machine to prevent turnover, damage and fuel spillage.

Refueling



Gasoline is highly flammable – keep away from fire or flame – do not spill any fuel – no smoking.

Always shut off the engine before refueling.

Do not fuel a hot engine – **fuel may spill and cause a fire.**

Open the fuel cap carefully to allow any pressure build-up in the tank to release slowly and avoid fuel spillage.

Only refuel the machine in a well ventilated place. If fuel has been spilled, immediately clean the machine – do not allow your clothes to be splashed with fuel. If that happens, change your clothes at once.



After refueling, close the fuel cap as tightly as possible.

This helps reduce the risk of engine vibrations causing an incorrectly tightened fuel cap to loosen or come off and spill fuel.

Check for leaks. Do not start the engine if there is a fuel leak – **serious or fatal burns could result!**

Before starting

Check that your power tool is properly assembled and in good condition – refer to appropriate chapters in the User Manual.

- Check the fuel system for leaks, especially the visible parts, e. g., fuel cap, hose connections, manual fuel pump (only in machines with a manual fuel pump). In case of leakage and damage, do not start the engine – **risk of fire!** Have the machine serviced by a dealer before using it
- Use only an approved combination of cutting attachment, deflector, handle and harness. All parts must be assembled properly and securely
- The stop switch must be easy to push
- Check the choke lever, throttle trigger and throttle trigger lockout for smooth action - throttle trigger must return automatically to idle position. The choke lever must spring back from the ▲ position to the run position I when the throttle trigger lockout and throttle trigger are squeezed.
- Check that the spark plug boot is secure – a loose boot may cause sparking that could ignite combustible fumes **and cause a fire!**
- Cutting attachment or interchangeable attachment: correctly fitted, secure and in perfect condition

- Safety devices (e. g., deflector for cutting attachments, rider plate) for damage and/or wear. Always replace damaged parts. Do not use the machine with a damaged deflector or worn rider plate (if the writing and arrows are no longer discernible)
- Never attempt to modify the controls or safety devices.
- Keep the handles dry and clean – free from oil and dirt – this is important for safe control of the machine
- Adjust the harness and handle(s) to suit your height and reach. Note the information in the chapters "Fitting the Harness" and "Balancing the Machine".

To reduce the risk of personal injury, do not operate your power tool if it is damaged or not properly assembled!

To prepare for emergencies when using a harness: Practice setting down the machine quickly. To avoid damage, do not throw the unit to the ground when practicing.

Starting the engine

Start the engine at least 3 meters from the fueling spot, outdoors only.

Place the unit on firm ground in an open area. Make sure you have good balance and secure footing. Hold the unit securely. The cutting attachment must be clear of the ground and all other obstructions because it may begin to run when the engine starts.

This is a one-person machine – ensure that there is no-one within 15 meters of the machine, not even when starting the power tool! **Risk of injury** due to ejected objects!



Avoid contact with the cutting attachment – **risk of injury!**



Do not drop-start the power tool – start the engine as described in the User Manual. The cutting attachment runs on for a short while after releasing the throttle trigger – **coasting effect!**

Keep easily combustible materials (e. g., wood chips, bark, dry grass, fuel) away from hot exhaust gases and hot muffler surfaces – **risk of fire!**

Holding and guiding the machine

Always hold the unit firmly with both hands on the handles.

Make sure you always have a firm and secure footing.

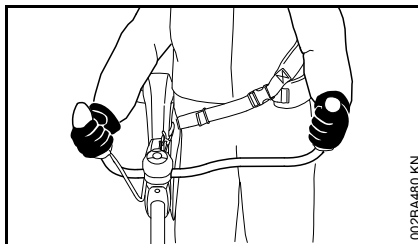

Right hand on control handle, left hand on grip on handlebar.

While working

Make sure you always have a firm and secure footing.

In the event of imminent danger or in an emergency, push the stop switch to stop the engine.

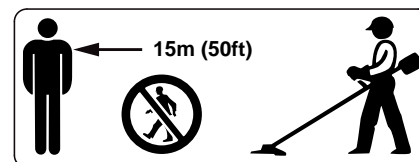

There is a risk of accident from ejected objects within a wide area around the working space, so you must ensure that there is no-one within a 15 m radius of the machine. This distance must also be maintained in relation to objects (vehicles, window panes) – **risk of property damage!** Even at distances beyond 15 m, the danger cannot be ruled out.

Check that the engine is properly idling so that the cutting tool will not continue rotating after you release the throttle trigger. If the cutting attachment still rotates at idle speed, have your dealer make proper adjustments or repairs. STIHL recommends you have this work done by a STIHL servicing dealer.

Take special care in slippery conditions – **damp, snow, ice**, on slopes or uneven ground.

Watch out for obstacles: tree stumps, roots – **risk of tripping or stumbling!**

Only work while standing on the ground, never on a ladder, work platform or other unstable surface.

Be particularly alert and cautious when wearing hearing protection because your ability to hear warnings (shouts, alarms, etc.) is restricted.

Take breaks when you start getting tired or feeling fatigue – **risk of accidents!**

Work calmly and carefully – in daylight conditions and only when visibility is good. Proceed with caution, do not put others in danger.



As soon as the engine is running, the power machine generates toxic exhaust gas. As soon as the engine is running, the power machine generates toxic exhaust gas. These gases may be odorless and invisible and may contain unburned hydrocarbons and benzene. Never run the engine indoors or in poorly ventilated locations, even if your model is equipped with a catalytic converter.

To reduce the risk of **serious or fatal injury from breathing toxic fumes**, ensure proper ventilation when working in trenches, hollows or other confined locations.

Stop work immediately if you start suffering from nausea, headaches, impaired vision (e.g. your field of vision gets smaller), impaired hearing, dizziness, or impaired concentration – these symptoms may possibly be the result of too-high exhaust gas concentration – **Risk of accidents!**

Operate your power tool so that it produces a minimum of noise and emissions – do not run the engine unnecessarily, accelerate the engine only when working.

To reduce the risk of fire, do not smoke while operating or standing near your power tool. Combustible fuel vapor may escape from the fuel system.

Dust, fumes and smoke produced while working may be hazardous to health. Wear respiratory protection in case of heavy dust or smoke emission.

If your power tool is subjected to unusually high loads for which it was not designed (e.g. heavy impact or a fall), always check that it is in good condition before continuing work – see also "Before Starting".

Check in particular that the fuel system has no leaks and the safety equipment is fully operative. Never use a power tool that is no longer safe to operate. In case of doubt, contact a dealer.



To reduce the risk of injury from thrown objects, never operate the unit without the proper deflector for the type of cutting attachment being used.



Check the work site – rocks, metal objects etc. could get caught up and ejected – potentially beyond a distance of 15 m – **risk of injury!** Such objects can also damage the cutting attachment and other property (e.g. parked vehicles, windows).

Be particularly careful when working on difficult, densely grown terrain.

When mowing in high shrubbery, under shrubbery and hedges: Hold the cutting tool at a working height of at least 15 cm – avoid risks to animals.

Always shut off the engine before leaving the unit unattended.

Examine the cutting attachment periodically at short intervals and as soon as you note any noticeable changes:

- Stop the engine, hold the machine securely, allow the cutting attachment to come to a stop
- Check condition and secure fitting; watch out for cracks
- Ensure that the cutting blades are sharp
- Replace damaged or blunt cutting attachments immediately, even in the event of minor hairline cracks

Clean grass and plant residue off the cutting attachment mounting at regular intervals – remove any accumulated material from the cutting attachment and deflector.

To reduce the risk of injury, shut off the engine before replacing the cutting attachment.



The gearbox gets hot during operation. Never touch the gearbox – **risk of burns!**

Do not continue using or attempt to repair damaged or cracked cutting attachments by means of welding, straightening or modifying the shape (unbalanced).

Particles or pieces may come off and hit the operator or a bystander at a high speed – **risk of most severe injuries!**

If a rotating cutting attachment touches a rock or another hard object, sparks may be generated which may possibly ignite combustible materials. Also dried-out plants and brushwood are combustible, above all in hot and dry weather. If there is a risk of fire, do not use cutting attachments in the vicinity of combustible materials, dried-out plants or brushwood. It is mandatory that you ask the responsible forestry office about current fire hazards.

Using mowing heads

Only use a deflector with a properly fitted blade, which limits the mowing line to the permissible length.

For manually adjustable mowing heads, always switch off the engine before adjusting the mowing line – **risk of injury!**

Misuse with mowing lines that are too long reduces the working speed of the engine. The constant slipping of the

clutch causes overheating and damage to important components (e. g. clutch, plastic housing parts) – e. g. due to the cutting attachment rotating during idling – **risk of injury!**

When using metal cutting attachments

STIHL recommends the use of original STIHL metal cutting attachments. These have been optimized for the machine and the user's requirements.

Metal cutting attachments rotate very fast, generating forces acting on the attachments and on the cuttings.

Metal cutting attachments must be sharpened in regular intervals in accordance with the instructions.

Unevenly sharpened metal cutting attachments generate an imbalance which may cause extreme loads on the machine – **risk of breakage!**

Dull or improperly sharpened cutting edges can put a higher load on the cutting attachment and increase the **risk of injury** from cracked or broken parts.

After each contact of the metal cutting attachment with hard objects (e.g. stones, rocks, metal parts), check it for damage (e.g. tears and deformation). Burrs and other visible accumulated material must be removed since it may come loose at any time while the machine is running and then be ejected – **risk of injury!**

To reduce the above-named risks involved in operating a metal cutting attachment, ensure that the diameter of your metal cutting attachment is not too big. Also, the attachment must not be

too heavy. It must be made of high-quality materials and have a suitable geometry (shape, thickness).

A metal cutting attachment not made by STIHL must not have a different weight, thickness, shape or a larger diameter than the largest STIHL metal cutting attachment approved for this metal cutting attachment – **risk of injury!**

Vibrations

Prolonged use of the power tool may result in vibration-induced circulation problems in the hands (whitefinger disease).

No general recommendation can be given for the length of usage because it depends on several factors.

The period of usage is prolonged by:

- Hand protection (wearing warm gloves)
- Work breaks

The period of usage is shortened by:

- Any personal tendency to suffer from poor circulation (symptoms: frequently cold fingers, tingling sensations).
- Low outside temperatures.
- The force with which the handles are held (a tight grip restricts circulation).

Continual and regular users should monitor closely the condition of their hands and fingers. If any of the above symptoms appear (e.g. tingling sensation in fingers), seek medical advice.

Maintenance and Repairs

Service the machine regularly. Do not attempt any maintenance or repair work not described in the instruction manual. Have all other work performed by a servicing dealer.

STIHL recommends that you have servicing and repair work carried out exclusively by an authorized STIHL servicing dealer. STIHL dealers are regularly given the opportunity to attend training courses and are supplied with the necessary technical information.

Only use high-quality replacement parts in order to avoid the risk of accidents and damage to the machine. If you have any questions in this respect, consult a servicing dealer.

STIHL recommends the use of original STIHL replacement parts. They are specifically designed to match your model and meet your performance requirements.

To reduce the risk of injury from unintentional engine startup, **always shut off the engine and disconnect the spark plug boot** before performing any repairs, maintenance or cleaning work. – Exception: Carburetor and idle speed adjustments.

Do not turn the engine over on the starter with the spark plug boot or spark plug removed since there is otherwise a **risk of fire** from uncontained sparking.

To reduce the **risk of fire**, do not service or store your machine near open flames.

Check the fuel filler cap for leaks at regular intervals.

Use only a spark plug of the type approved by STIHL and make sure it is in good condition – see "Specifications".

Inspect the ignition lead (insulation in good condition, secure connection).

Check the condition of the muffler.

To reduce the **risk of fire and damage to hearing**, do not operate your machine if the muffler is damaged or missing. –

Do not touch a hot muffler since **burn injury** will result.

Vibration behavior is influenced by the condition of the AV elements – check the AV elements at regular intervals.

Symbols on Deflectors

An **arrow** on the deflector shows the correct direction of rotation of the cutting attachments.

Some of the following symbols are applied to the outside of the deflector to indicate the approved combination of cutting attachment and deflector.



Deflector may be used with mowing heads.



Deflector may be used with grass cutting blades.



Deflector may be used with brush knives.



Deflector may be used with shredder blades.



Deflector must not be used with mowing heads.



Deflector must not be used with grass cutting blades.



Deflector must not be used with brush knives.



Deflector must not be used with shredder blades.



Deflector must not be used with circular saw blades.

Harness

The harness is included with the machine or available as a special accessory.

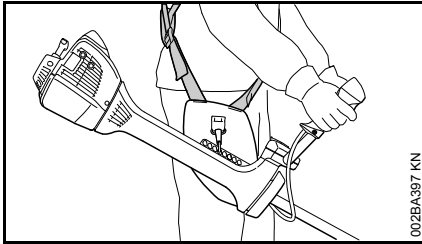

- Use the harness.
- With the engine running, attach the machine to the harness.

All cutting attachments must be used in combination with a full harness with a quick-release system.

Mowing Head with Nylon Line

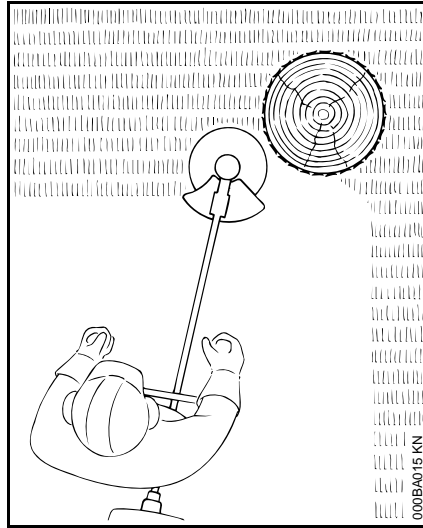

Nylon line achieves a soft cut for edging and trimming around trees, fence posts, etc. – less risk of damaging tree bark.

The mowing head comes with an instruction leaflet. Refill the mowing head with nylon line as described in the instruction leaflet.

! WARNING

To reduce the risk of serious injury, never use wire or metal-reinforced line in place of the nylon line.

STIHL DuroCut

Check the wear limit marks!

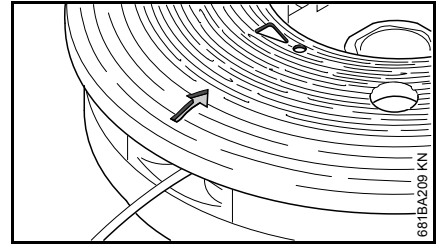

If one of the wear limit marks imbedded in the baseplate of the DuroCut (**exclamation marks**) becomes visible, do not continue using the mowing head since it may otherwise be damaged.

Replace the worn baseplate.

The mowing head comes with instruction leaflets. Equip the mowing head only with nylon line as described in the instruction leaflets.

! WARNING

Never use wire in place of the nylon mowing line – **risk of injury.**

STIHL Polycut Mowing Head with Polymer Blades

For mowing unobstructed edges of meadows (without posts, fences, trees or similar obstacles).

Check the wear limit marks!

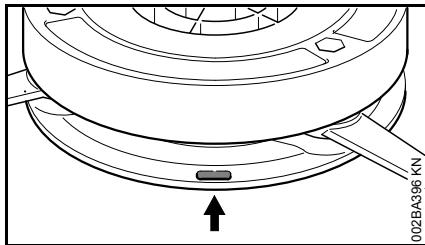

If one of the wear limit marks on the PolyCut mowing head is worn through (arrow): Do not continue using the mowing head. Install a new one. There is otherwise a **risk of injury** from thrown parts of the head.

It is important to follow the maintenance instructions for the PolyCut mowing head.

The PolyCut can also be equipped with mowing line in place of the polymer blades.

The mowing head comes with instruction leaflets. Equip the mowing head with polymers blades or nylon line as described in the instruction leaflets.

! WARNING

Never use wire in place of the nylon mowing line – **risk of injury**.

Risk of Kickout (Blade Thrust) with Metal Cutting Attachments

! WARNING



When using metal cutting attachments there is a risk of kickout when the rotating blade comes into contact with a solid object such as a tree trunk, branch, tree stump, rock or similar. The machine is thrown to the right or to the rear – opposite to the attachment's direction of rotation.

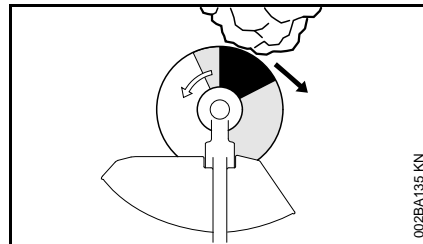

The **risk of kickout is greatest** when the **black area** of the rotating cutting attachment comes into contact with a solid object.

Grass Cutting Blade

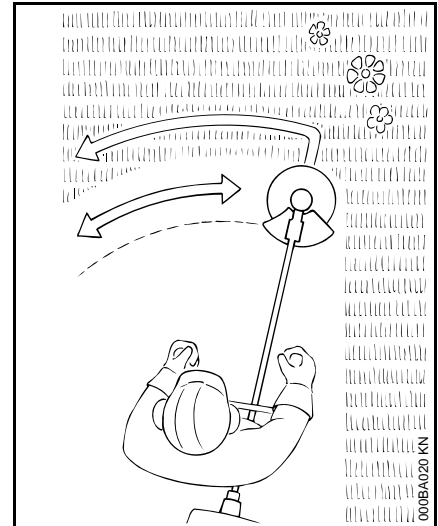

Use for grass and weeds only – sweep the brushcutter in an arc like a scythe.

! WARNING

Improper use may damage the grass cutting blade – **risk of injury** from thrown parts.

Resharpener the grass cutting blade according to instructions when it has dulled noticeably.

Brush Knife

For cutting matted grass, wild growth and scrub and thinning young stands with a stem diameter of no more than 2 cm – do not cut thicker stems – **risk of accidents**.

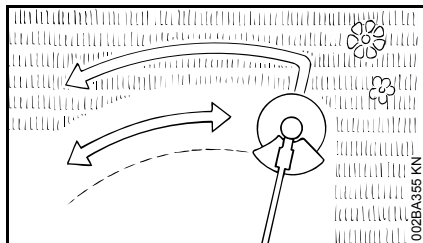

Use the brushcutter like a scythe (sweep it to the right and left) at ground level when cutting grass and thinning young stands.

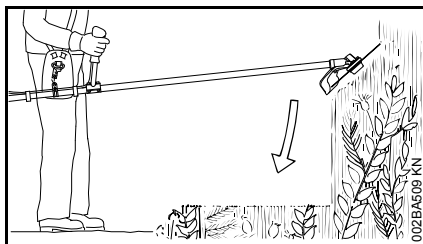

To cut wild growth and scrub, lower the brush knife down onto the growth to achieve a shredding effect – always keep the cutting attachment below hip level during this process.

Exercise extreme caution when using this method of cutting. The higher the cutting attachment is off the ground, the greater the risk of injury from cuttings being thrown sideways.

Warning! Improper use of a brush knife may cause it to crack, chip or shatter – **risk of injury** from thrown parts.

To reduce the risk of injury it is essential to take the following precautions:

- Avoid contact with stones, rocks, pieces of metal and other solid foreign objects.
- Never cut wood or shrubs with a stem diameter of more than 2 cm – use a circular saw blade for such work.
- Inspect the brush knife at regular short intervals for signs of damage. Do not continue working with a damaged brush knife.
- Resharpener the brush knife regularly and whenever it has dulled noticeably, and have it balanced if necessary (STIHL recommends a STIHL servicing dealer).

Shredder Blade

Suitable for thinning and shredding tough, matted grass and scrub.

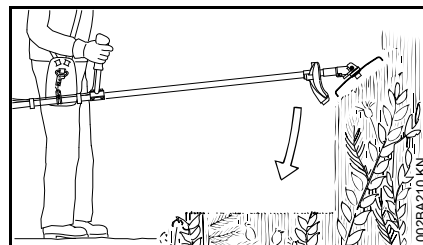

To cut wild growth and scrub, lower the shredder blade down onto the growth to achieve a shredding effect – always keep the cutting attachment below hip level during this process.

Exercise extreme caution when using this method of cutting. The higher the cutting attachment is off the ground, the greater the risk of injury from cuttings being thrown sideways.

Warning! Improper use may damage the shredder blade – **risk of injury** from thrown parts.

To reduce the risk of injury it is essential to take the following precautions:

- Avoid contact with stones, rocks, pieces of metal and other solid foreign objects.
- Never cut wood or shrubs with a stem diameter of more than 2 cm – use a circular saw blade for such work.
- Inspect the shredder blade at regular short intervals for signs of damage. Do not continue working with a damaged shredder blade.
- Resharpener the shredder blade regularly and whenever it has dulled noticeably, and have it balanced if necessary (STIHL recommends a STIHL servicing dealer).

Circular Saw Blade

Suitable for cutting shrubs and trees with a maximum stem diameter of 7 cm.

Before starting the cut, accelerate the engine up to full throttle. Perform cut with uniform pressure.

Use circular saw blades only with a matching limit stop of the correct diameter.

! WARNING

To reduce the risk of blade damage, avoid contact with stones and the ground. Resharpener the blade properly in good time – dull teeth may result in the blade cracking and shattering and causing serious injury.

When felling, maintain a distance of at least two tree lengths from the next felling site.

Risk of kickout

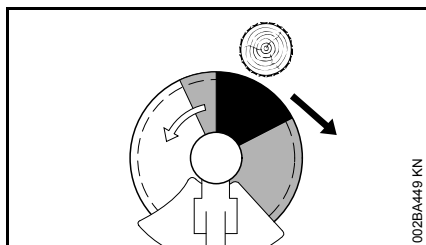

The risk of kickout is highest in the black area of the blade: Do not use this area of the circular saw blade for cutting.

There is also a risk of kickout when using the lighter shaded areas of the blade: These areas of the blade should only be used by experienced operators with specialized training.

STIHL recommends that you use the non-shaded area of the circular saw blade. Always start the cut with this area of the blade.

Approved Combinations of Cutting Attachment, Deflector, Limit Stop and Harness

Cutting attachment

Deflector, limit stop

Carrying strap

<p>1 2 3 4 5 6 7</p>	<p>21</p>	<p>26</p>
<p>8 9 10 11 12 13 14</p>	<p>22</p>	
<p>15</p>	<p>23</p>	
<p>16 17</p>	<p>24</p>	
<p>18 19 20</p>	<p>25</p>	

0000-GXX-0417-A0

Permissible combinations

Choose the correct combination from the table depending on the cutting tool!

WARNING

For safety reasons only the cutting attachments and deflectors and/or limit stops within one line of the table may be combined with one another. No other combinations are permitted because of the **risk of accidents!**

Cutting attachments

Mowing heads

- 1 STIHL SuperCut 40-2
- 2 STIHL AutoCut 40-2
- 3 STIHL AutoCut 40-4¹
- 4 STIHL AutoCut 46-2
- 5 STIHL TrimCut 41-2
- 6 STIHL DuroCut 40-4
- 7 STIHL PolyCut 41-3

Metal cutting tools

- 8 Grass cutting blade 230-4 (Ø 230 mm)
- 9 Grass cutting blade 250-32 (Ø 250 mm)
- 10 Grass cutting blade 250-40 Spezial (Ø 250 mm)

1) approved for FS 460 C-M and FS 490 C-M only

- 11 Grass cutting blade 250-44 (250 mm dia.)²
- 12 Grass cutting blade 255-8 (Ø 255 mm)
- 13 Brush knife 305-2 Spezial (Ø 305 mm)
- 14 Brush knife, 300-3 (Ø 300 mm)
- 15 Shredder blade 270-2 (Ø 270 mm)
- 16 Circular saw blade 200 scratcher tooth (Ø 200 mm)
- 17 Circular saw blade 200-22 chisel tooth (4119), circular saw blade 200-22 HP chisel tooth (4000)
- 18 Circular saw blade 225 scratcher tooth (Ø 225 mm)
- 19 Circular saw blade 225 chisel tooth (Ø 225 mm)
- 20 Circular saw blade 225 (carbide-tipped) (225 mm dia.)

WARNING

Non-metal grass cutting blades, brush knives, shredder blades and circular saw blades are not permitted.

Guards, limit stops

- 21 Deflector for mowing heads

2) not approved for FS 410 C

- 22 Guard for metal cutting tools, items 8 to 14
- 23 Guard for shredder blades
- 24 Limit stop for circular saw blades, items 16 to 17
- 25 Limit stop for circular saw blades, items 18 to 20

Carrying strap

- 26 Full harness must be used

Mounting the Bike Handle

Mounting Bike Handle with Swivelling Handle Support

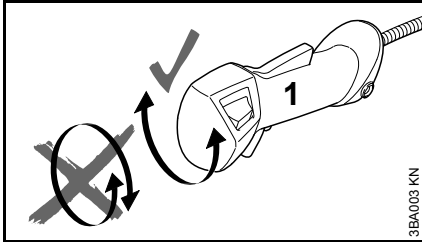

Do not rotate the control handle (1) between unpacking and mounting it on the handlebar; see also chapter on "Adjusting the Throttle Cable".

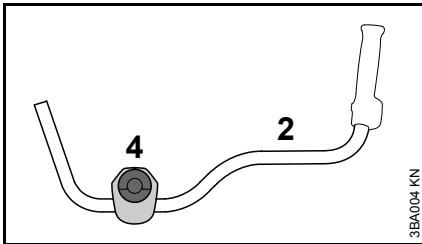

The machine is shipped with the clamp moldings (4) mounted on the handlebar (2).

- Do not change the position of the clamp moldings on the handlebar until the control handle is mounted.

Mounting the Handlebar

To assemble the swivelling handle support it is necessary to fit a spring in the clamps and secure them to the handle support on the machine.

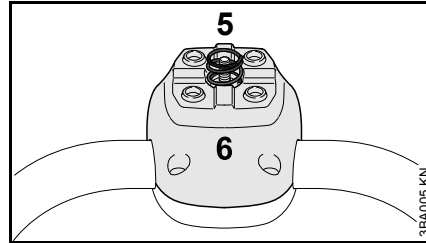

- Use the spring (5) from the parts kit supplied with the machine.
- Push the spring (5) into the lower clamp molding (6).

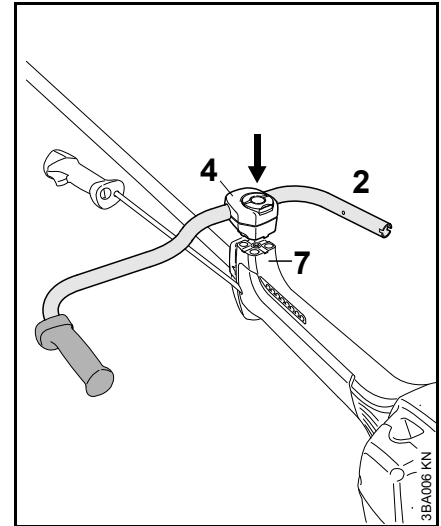

- Position the clamp moldings (4) with handlebar (2) on the handle support (7).
- Do not rotate the handlebar in the clamp moldings.

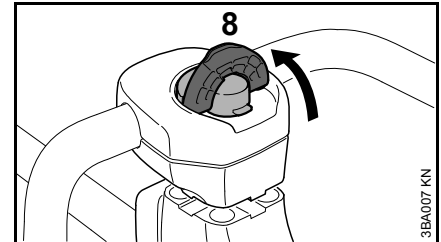

- Raise the grip of the wing screw (8) to the upright position.

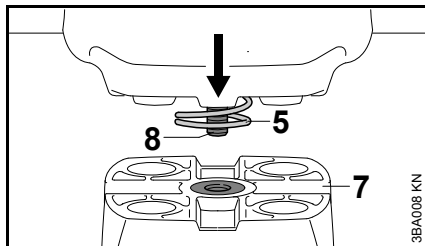

- Position wing screw (8) in threaded insert in handle support (7) – against pressure of spring (5).

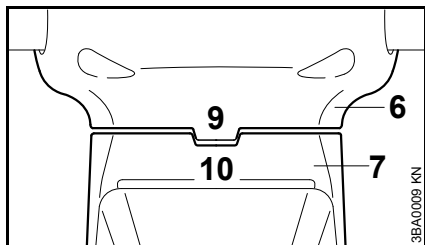

- Position the clamp moldings so that the tabs (9) on the lower clamp molding (6) line up with the slots (10) in the handle support (7).

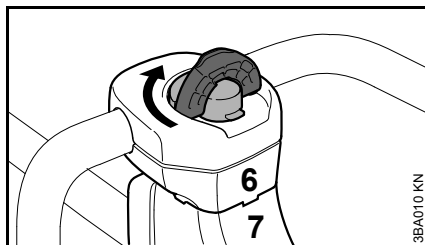

- Rotate wing screw clockwise until the lower clamp molding (6) butts against the handle support (7).
- Only tighten the wing screw moderately.

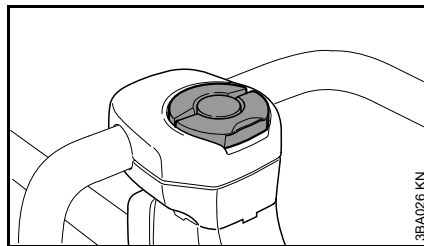

- Fold the grip of the wing screw down so that it is flush.

Mounting the Control Handle

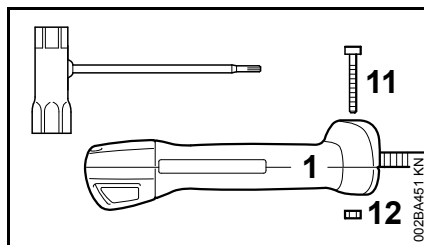

- Take out the screw (11) and remove the nut (12) from the control handle (1).

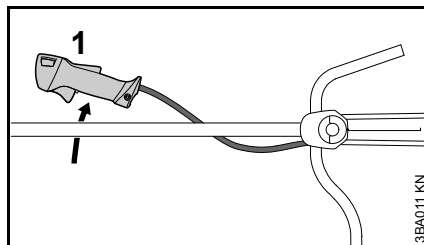

- Pass the control handle (1) under the drive tube and put it down on the right-hand side of the machine.

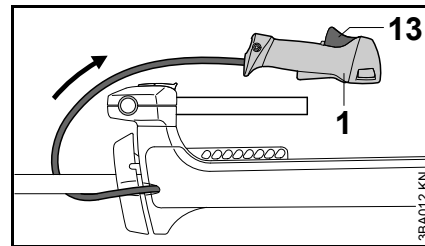

- Swing the control handle (1) behind the handlebar so that the throttle trigger (13) is facing up.

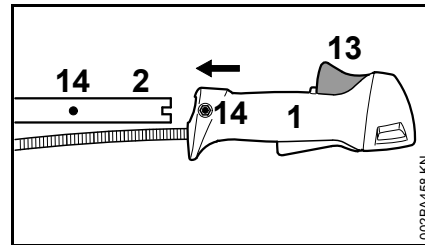

- Push the control handle (1) in this position onto the end of the handlebar (2) until the holes (14) are in alignment – the throttle trigger (13) points up.

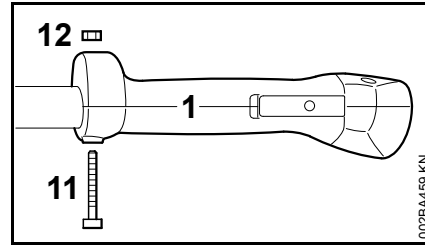

- Fit the nut (12) in the control handle (1), insert the screw (11) and tighten it down firmly.

Adjusting the Handlebar

Opening the wing screw

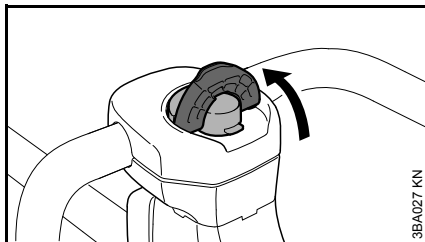

- Raise the grip of the wing screw to the upright position.

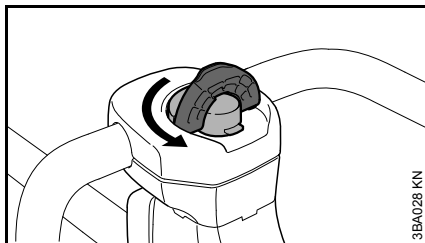

- Turn the wing screw counterclockwise until the handle support can be moved.

Line up the handlebar

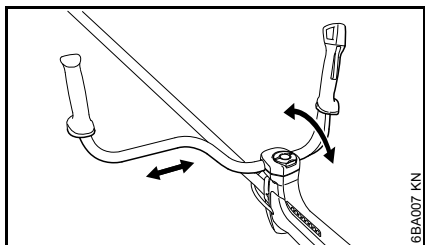

- Move the handlebar to the required position.

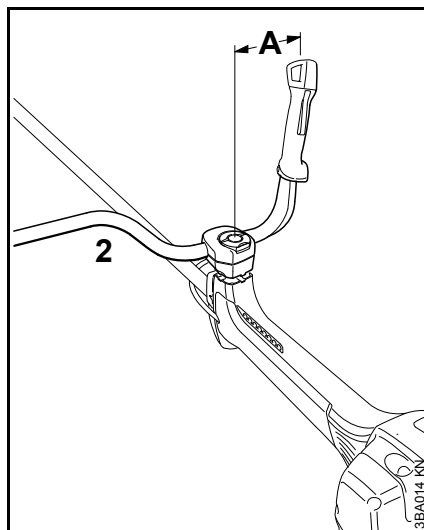

- Position the handlebar (2) so that distance A is about 17 cm (7 in).

Do not clamp the curved part of the handlebar.

Closing the wing screw

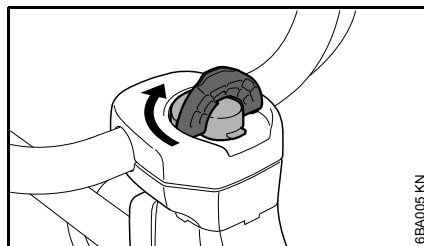

- Rotate the wing screw clockwise until it becomes difficult to turn.
- Tighten down the wing screw firmly.

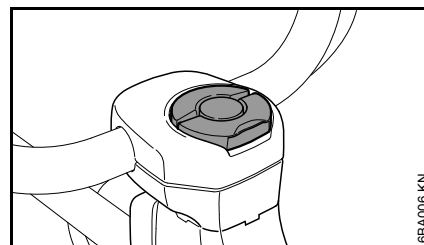

- Fold the grip of the wing screw down so that it is flush.

Checking the Throttle Cable

- After mounting the control handle, check the throttle cable – see chapter on "Adjusting the Throttle Cable".

Swiveling the Handlebar

Transport position

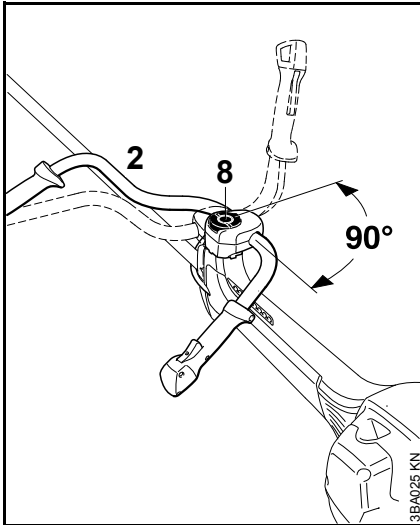

- Loosen the wing screw (8) and unscrew it until the handlebar (2) can be turned clockwise.
- Turn the handlebar 90° and then swing the handles down.
- Tighten down the wing screw (8) firmly.

Working position

- Reverse the sequence described above to swing the handles up and turn the handlebar counterclockwise.

Adjusting the Throttle Cable

It may be necessary to correct the adjustment of the throttle cable after assembling the machine or after a prolonged period of operation.

Adjust the throttle cable only when the unit is completely and properly assembled.

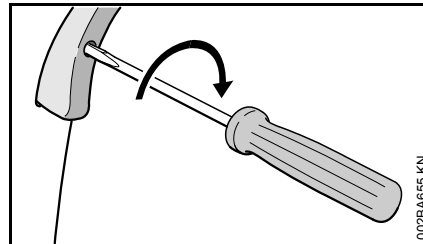

- Set the throttle trigger to the full throttle position.
- Carefully rotate the screw in the throttle trigger in the direction of the arrow until you feel initial resistance. Then rotate it another half turn in the same direction.

Mounting the Deflector

Use the Right Deflector

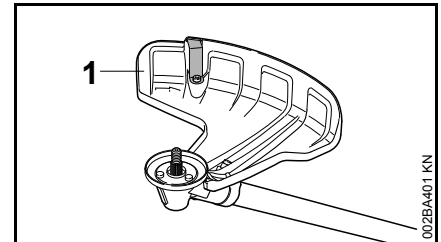

! WARNING

Deflector (1) is approved for mowing heads only and must therefore be mounted before fitting a mowing head.

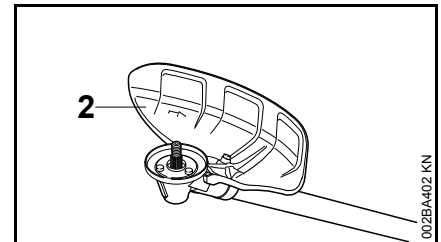

! WARNING

Deflector (2) is approved for grass cutting blades and brush knives only and must therefore be mounted before fitting a grass cutting blade or brush knife.

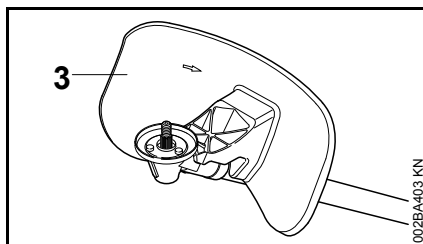

! WARNING

Deflector (3) is approved for shredder blades only and must therefore be mounted before fitting a shredder blade.

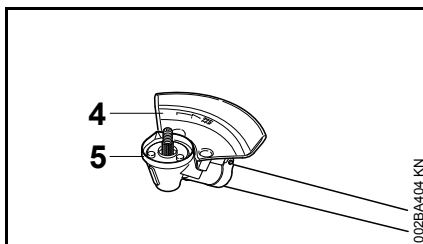

! WARNING

The limit stop (4) is approved as a deflector for circular saw blades only and must therefore be mounted before fitting a circular saw blade. It is also necessary to change the guard ring (5), see "Mounting the Cutting Attachment" / "Mounting Circular Saw Blades".

Mounting the Deflector

Deflectors (1 to 4) are mounted to the gearbox in the same way.

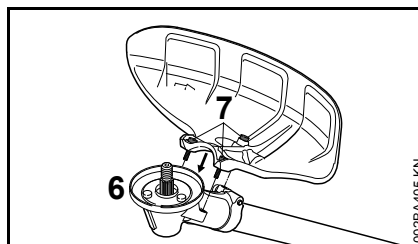

- Remove dirt from joints on gearbox and deflector – make sure that no dirt gets into the screw holes in the gearbox.
- Place the deflector on the gearbox (6).
- Insert the screws (7) and tighten them down firmly.

Mounting the Cutting Attachment

Placing power tool on the ground

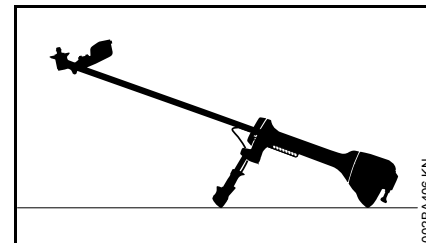

- Shut off the engine.
- Lay your power tool on its back so that the cutting attachment mounting face is pointing up.

Use the Right Guard Ring

Your power tool comes standard with a guard ring.

The guard ring is also available as a special accessory.

The guard ring must be mounted with particular care. Have this work performed by your servicing dealer. STIHL recommends a STIHL servicing dealer.

Guard ring for mowing applications

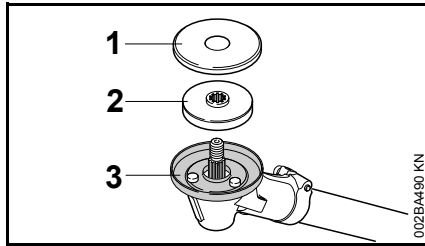

Always fit guard ring (1) when using

- mowing heads
- grass cutting blades
- brush knives
- shredder blades

to ensure optimum protection against grass cuttings.

Guard ring for sawing applications

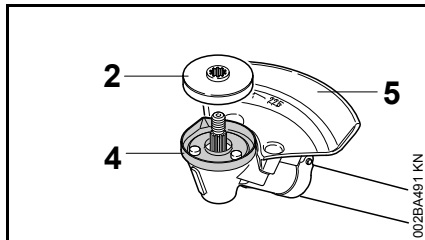

Fit guard ring (4) only when you use circular saw blades.

Mounting the Thrust Plate and Guard Washer

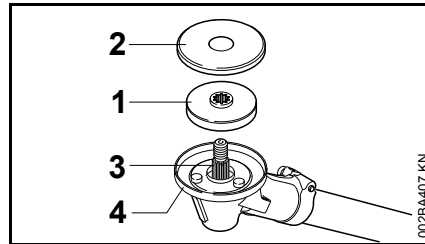

- Fit the thrust plate (1) and guard washer (2) on the shaft (3).



NOTICE

The thrust plate (1) on the gearbox is necessary for mounting all cutting attachments.



NOTICE

The guard washer (2) is required for mounting

- mowing heads
- grass cutting blades
- brush knives
- shredder blades

to the gearbox. The guard washer is not required for mounting circular saw blades.

Checking the Thrust Plate

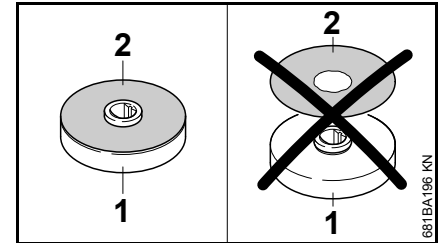

The thrust plate consists of the thrust plate body (1) to which a captive guard washer (2) is fitted.



WARNING

Never use a thrust plate without the guard washer. Always replace a thrust plate if the guard washer is missing.

Cleaning Gearbox Mounting Hardware for Cutting Attachment

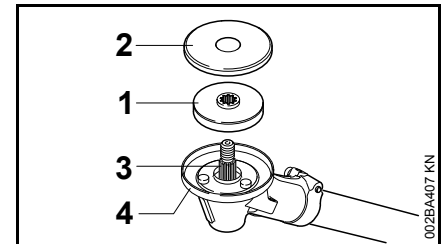

NOTICE

Check inside of guard ring (4) and area around it for dirt at regular intervals, or when you change the cutting attachment, and clean if necessary as follows:

- Pull the guard washer (1) and thrust plate (2) off the shaft.
- Thoroughly clean the guard ring, shaft, thrust plate and guard washer – do not remove the guard ring.

Blocking the Shaft

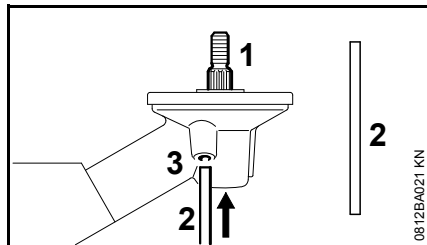

The output shaft (1) must be blocked with the stop pin (2) to mount or remove cutting attachments. The stop pin is included with the machine and is available as a special accessory.

- Insert the stop pin (2) in the bore (3) in the gearbox as far as stop, apply slight pressure.
- Rotate shaft or cutting attachment until the stop pin slips into position and blocks the shaft.

Mounting the Cutting Attachment



WARNING

Use a deflector that matches the cutting attachment – see "Mounting the Deflector".

Fitting the mowing head with screw mounting

Keep the supplement sheet for the mowing head in a safe place.

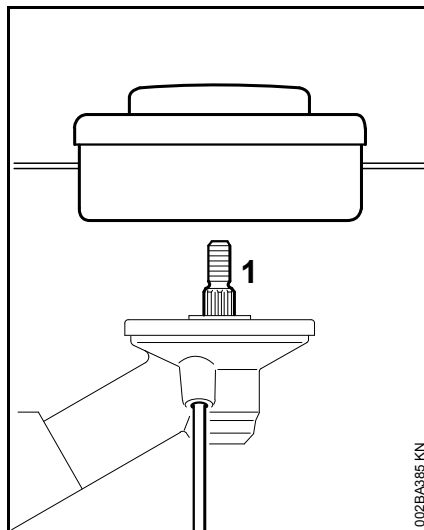

- Fit the thrust plate
- Turn the mowing head anticlockwise on the shaft (1) as far as it will go
- Retain the shaft
- Tighten the mowing head



NOTICE

Remove the tool that was used to block the shaft.

Removing the Mowing Head

- Retain the shaft
- Turn the mowing head clockwise

Removing and Installing Metal Cutting Attachments

Keep the leaflet and packaging of the metal cutting attachment in a safe place.



WARNING

Wear protective gloves to reduce the risk of direct contact with the sharp cutting edges.

Mount only one metal cutting attachment.

Mounting Grass Cutting Blades, Brush Knife

Notice on new machines that come standard with a mowing head only: A "metal mowing attachment mounting kit" is required to mount a grass cutting blade or brush knife. Kits are available from your servicing dealer.

Check direction of rotation of cutting attachment

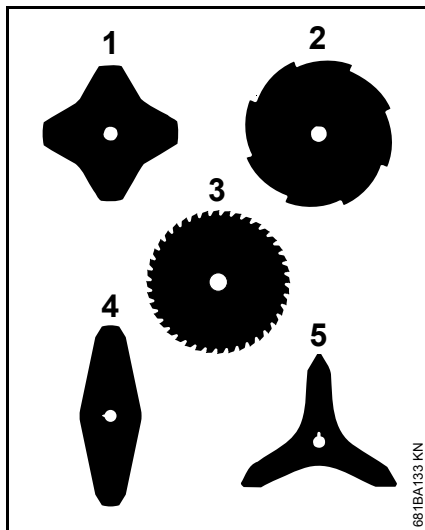

Cutting attachments 1, 4 and 5 may be mounted either way round – they must be turned over regularly to help avoid one-sided wear.

The cutting edges of cutting attachments 2 and 3 must point clockwise.

- Use guard ring for mowing attachments.

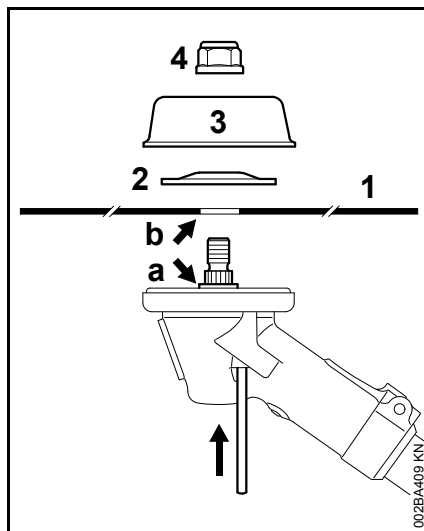

- Place the cutting attachment (1) in position.

WARNING

Collar (a) must locate in the cutting attachment's mounting hole (b).

Securing the cutting attachment

- Fit the thrust washer (2) – convex side must face up.
- Fit the rider plate (3).
- Block the shaft.
- Fit the nut (4) counterclockwise and tighten it down firmly.

WARNING

If the mounting nut has become too loose, fit a new one.

NOTICE

Remove the tool used to block the shaft.

Removing the cutting attachment

- Block the shaft.
- Unscrew the mounting nut clockwise.
- Pull the cutting attachment with its mounting hardware off the gearbox.

Mounting Shredder Blade 270-2

Notice on new machines that come standard with a mowing head only: In addition to the "shredder blade mounting kit", a "shredder blade retrofit kit" is required to mount a shredder blade. Kits are available from your servicing dealer.

- Use guard ring for mowing attachments.

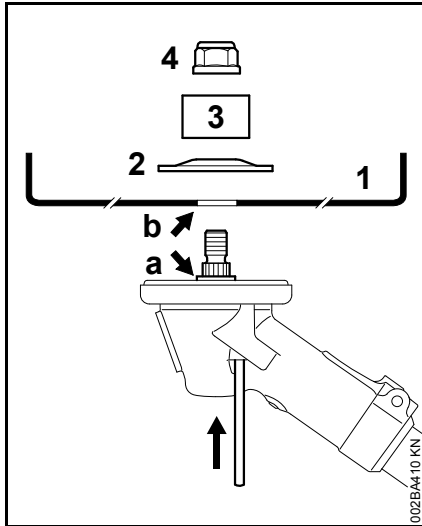

- Place the shredder blade (1) in position – the cutting edges must point upwards.

! WARNING

Collar (a) must locate in the cutting attachment's mounting hole (b).

Securing the cutting attachment

- Fit the thrust washer (2) – convex side must face up.
- Fit the shredder blade guard ring (3) – opening must face up.
- Block the shaft.
- Fit the nut (4) counterclockwise and tighten it down firmly.

! WARNING

If the mounting nut has become too loose, fit a new one.

⚙ NOTICE

Remove the tool used to block the shaft.

Removing the cutting attachment

- Block the shaft.
- Unscrew the mounting nut clockwise.
- Pull the cutting attachment with its mounting hardware off the gearbox.

Mounting Circular Saw Blades

A limit stop kit, which includes a limit stop and a guard ring for circular saw blades, is available as a special accessory for mounting circular saw blades.

Notice on new machines that come standard with a mowing head only: Further mounting hardware is necessary for a circular saw blade. It is available from your servicing dealer.

Change the guard ring.

Recommendation: The guard ring must be mounted with particular care. Have this work performed by your servicing dealer. STIHL recommends a STIHL servicing dealer.

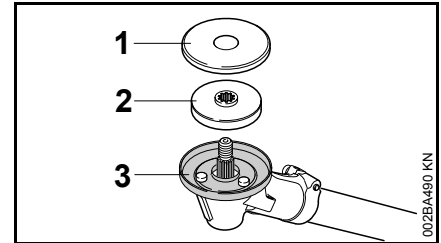

- Remove the guard washer (1) and thrust plate (2).
- Remove the guard ring (3) for mowing attachments.
- Keep the guard washer and guard ring in a safe place for future use.

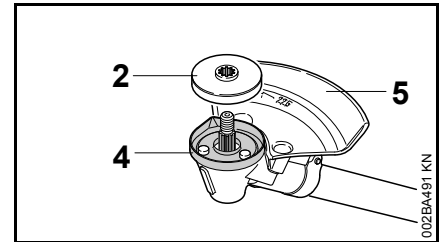

- Fit the guard ring (4) for saw blades.
- Slip the thrust plate (2) over the shaft.
- Fit the limit stop (5) for circular saw blades.

⚙ NOTICE

Do not use the guard washer (1) with circular saw blades.

Check direction of rotation of cutting attachment

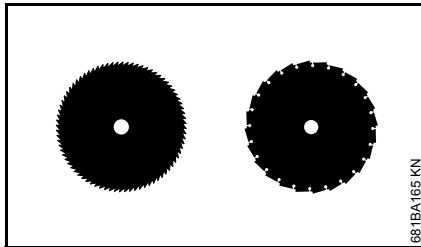

Cutting edges of circular saw blades must point clockwise.

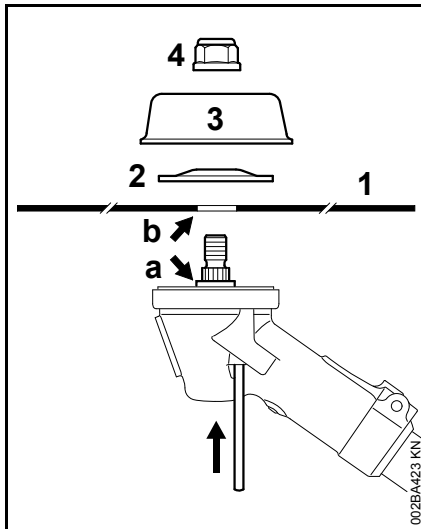

- Place the cutting attachment (1) in position.

WARNING

Collar (a) must locate in the cutting attachment's mounting hole (b).

Securing the cutting attachment

- Fit the thrust washer (2) – convex side must face up.
- Fit the rider plate (3).

A rider plate (3) for sawing applications is available as a special accessory. It allows the full depth of cut of the saw blade to be used.

- Block the shaft.
- Fit the nut (4) counterclockwise and tighten it down firmly.

WARNING

If the mounting nut has become too loose, fit a new one.

NOTICE

Remove the tool used to block the shaft.

Removing the cutting attachment

- Block the shaft.
- Unscrew the mounting nut clockwise.
- Pull the cutting attachment with its mounting hardware off the gearbox.

Fuel

Your engine requires a mixture of gasoline and engine oil.

WARNING

For health reasons, avoid direct skin contact with gasoline and avoid inhaling gasoline vapor.

STIHL MotoMix

STIHL recommends the use of STIHL MotoMix. This ready-to-use fuel mix contains no benzol or lead, has a high octane rating and ensures that you always use the right mix ratio.

STIHL MotoMix uses STIHL HP Ultra two-stroke engine oil for an extra long engine life.

MotoMix is not available in all markets.

Mixing Fuel

NOTICE

Unsuitable fuels or lubricants or mix ratios other than those specified may result in serious damage to the engine. Poor quality gasoline or engine oil may damage the engine, sealing rings, hoses and the fuel tank.

Gasoline

Use only high-quality **brand-name** gasoline with a minimum octane rating of 90 – leaded or unleaded.

Gasoline with an ethanol content of more than 10% can cause running problems in engines with a manually adjustable carburetor and should not be used in such engines.

Engines equipped with M-Tronic deliver full power when run on gasoline with an ethanol content of up to 25% (E25).

Engine Oil

If you mix the fuel yourself, use only STIHL two-stroke engine oil or another high-performance engine oil in accordance with JASO FB, JASO FC, JASO FD, ISO-L-EGB, ISO-L-EGC or ISO-L-EGD.

STIHL specifies STIHL HP Ultra two-stroke engine oil or an equivalent high-performance engine oil in order to maintain emission limits over the machine's service life.

Mix Ratio

STIHL 50:1 two-stroke engine oil: 50 parts gasoline to 1 part oil

Examples

Gasoline Liters	STIHL engine oil 50:1 Liters (ml)	
1	0.02	(20)
5	0.10	(100)
10	0.20	(200)
15	0.30	(300)
20	0.40	(400)
25	0.50	(500)

- Use a canister approved for storing fuel. Pour oil into canister first, then add gasoline and mix thoroughly.

Storing Fuel

Store fuel only in approved safety-type fuel canisters in a dry, cool and safe location protected from light and the sun.

Fuel mix ages – only mix sufficient fuel for a few weeks work. Do not store fuel mix for longer than 30 days. Exposure to light, the sun, low or high temperatures can quickly make the fuel mix unusable.

STIHL MotoMix may be stored for up to 2 years without any problems.

- Thoroughly shake the mixture in the canister before fueling your machine.

WARNING

Pressure may build up in the canister – open it carefully.

- Clean the fuel tank and canister from time to time.

Dispose of remaining fuel and cleaning fluid properly in accordance with local regulations and environmental requirements.

Fueling

Fuel Filler Cap

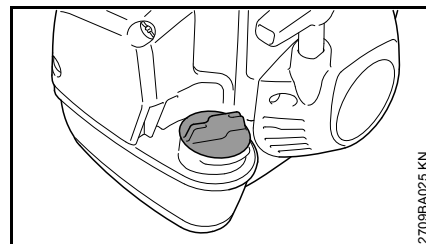

WARNING

When fueling on a slope, always position the machine with the filler cap facing uphill.

- Place the machine on level ground so that the filler cap is facing up.
- Before fueling, clean the filler cap and the area around it to ensure that no dirt falls into the tank.

Opening the filler cap

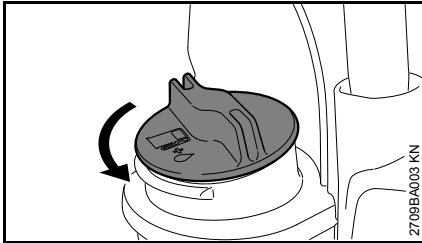

- Turn the cap counterclockwise until it can be removed from the tank opening.
- Remove the cap.

Filling Up with Fuel

Take care not to spill fuel while fueling and do not overfill the tank.

STIHL recommends you use the STIHL filler nozzle for fuel (special accessory).

- Fill up with fuel.

Closing the filler cap

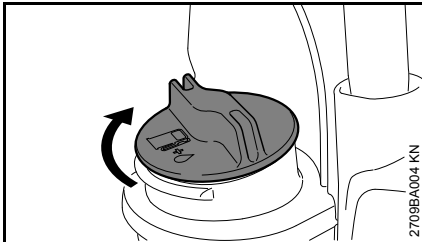

- Place the cap in the opening.
- Turn the cap clockwise as far as stop and tighten it down as firmly as possible by hand.

Fitting the Full Harness

Fitting the full harness is described in detail in the leaflet supplied with the harness.

The type and style of the harness depend on the market.

Fitting the Harness

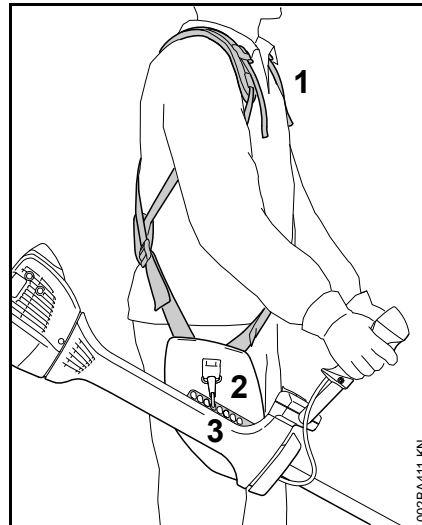

- Put on the full harness (1).
- Adjust the length of the strap so that the carabiner (2) is about a hand's width below your right hip.
- Attach the carabiner to the machine's perforated rail (3) – see "Attaching Machine to Harness".
- Find the right attachment point for the cutting attachment you are using – see "Balancing the Machine".

Attaching Machine to Harness

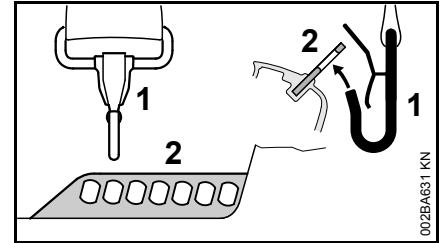

- Attach the carabiner (1) to the perforated rail (2) on the drive tube.

Disconnecting Machine from Harness

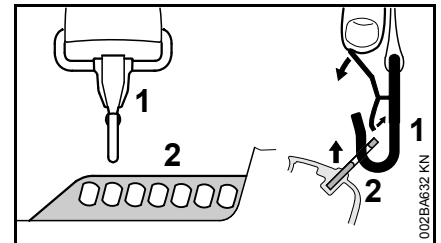

- Press down the bar on the carabiner (1) and pull the perforated rail (2) out of the carabiner.

Balancing the Machine

The machine will balance differently depending on the cutting attachment mounted.

- Let the machine swing on the harness until it stops moving – change the connection point if necessary

Hanging positions

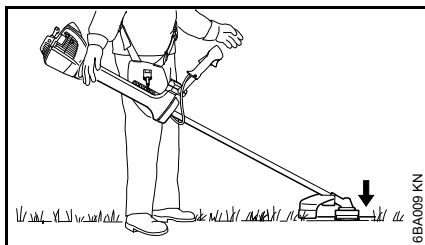

Mowing heads, grass cutting blades, brush knives and shredder blades should rest lightly on the ground.

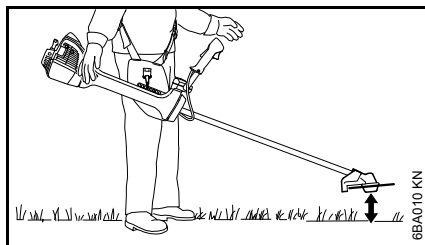

Circular saw blades should "hover" approx. 20 cm above the ground.

Putting down the machine in an emergency

WARNING

As soon as it becomes apparent that a dangerous situation is developing, the machine must be put down quickly. Practice setting down the machine quickly. In order to avoid damage, when practicing, do not throw the machine on the ground.

Starting / Stopping the Engine

Controls

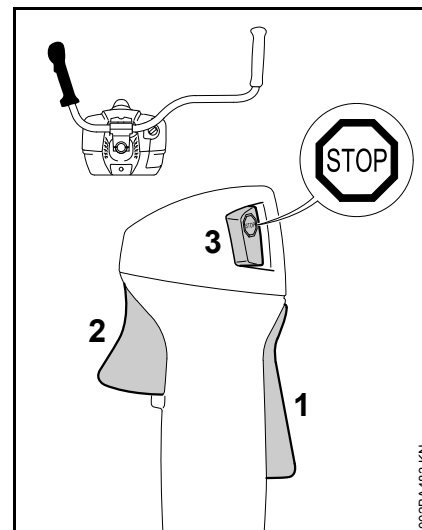

- 1 Throttle trigger lockout
- 2 Throttle trigger
- 3 Stop switch – with settings for Run and Stop. Press the stop switch to switch off the ignition.

Function of the stop switch and the ignition

When the stop switch is not actuated, it is in the position Run: The ignition is switched on – the engine is ready for starting and can be started. If the stop switch is actuated, the ignition is switched off. Once the engine comes to a standstill, the ignition is automatically switched on again.

Symbols on the choke lever

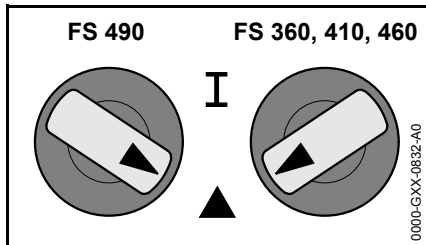

Operating position I- in this position the warm engine is started or the engine is running.

Start ▲ – in this position the cold engine is started

Starting the engine

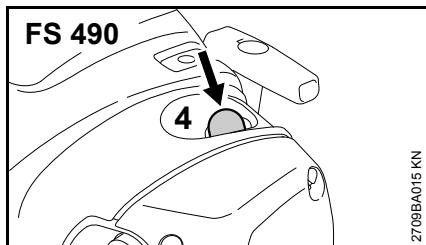
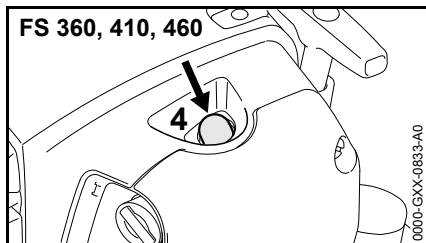

- Press the manual fuel pump bulb (4) at least five times - even when bulb is filled with fuel

The choke lever is in the operating position I.

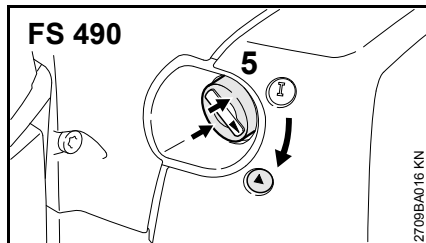
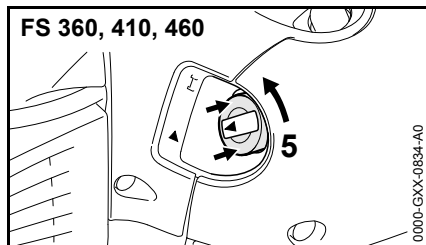

- If the engine is cold: Press in the choke lever (5) at the edge (arrows) and turn to the start position ▲ .

Starting

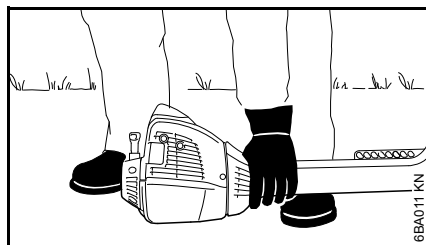

- Place the machine on the ground in a secure position: It must rest on the hip plate on the engine and the deflector for the cutting attachment.

The cutting attachment must not touch the ground or any other objects

- Adopt a stable position - either standing, bending over or kneeling
- Press the machine firmly against the ground with the left hand – do not touch the throttle trigger or throttle trigger lockout while doing so



NOTICE
Do not stand or kneel on the shaft!

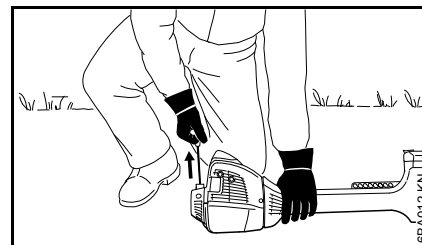

- Grab the starter grip with your right hand
- Pull the starter grip smoothly



NOTICE
Do not pull out the starter rope completely – risk of breakage!

- Do not let the starter grip snap back – guide it slowly back into the housing so that the starter rope can rewind properly
- Repeat this procedure until the engine starts
- If the engine still does not start: Turn the choke lever to the start position ▲ and restart the tool.

Using the tool

If the tool is put into operation for the first time, then observe the notes "First start-up" in the section "Further notes on starting".

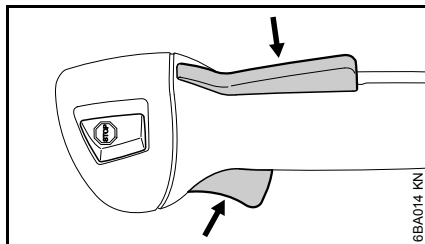

- If the engine has been started in the start position ▲ : Simultaneously press briefly the throttle trigger lockout and the throttle trigger; the choke lever jumps to operating position I and the engine begins to idle

The machine is now ready for use.

! WARNING

In the position for operation I and simultaneous engine idling, the cutting attachment must not rotate!

If the cutting attachment rotates when the engine is idling, follow the instructions in the chapter "Adjusting the throttle cable" or have the tool repaired by a specialist dealer. STIHL recommends STIHL servicing dealers.

- Connecting machine to harness
- Using the tool

Switching off engine

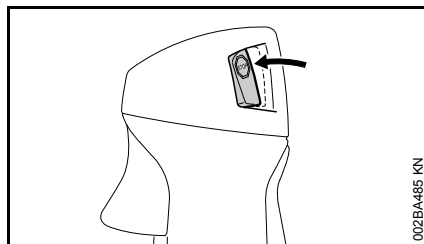

- Press stop switch – the engine stops – release stop switch – the stop switch returns to its original position

Further notes on starting

First start-up

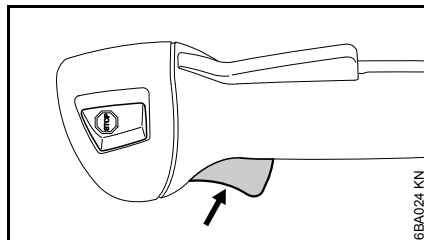

- Press throttle trigger – do not actuate throttle trigger lockout

If the engine speed increases or if the cutting attachment turns too, then:

- continue in section "Switching off engine"
- continue in chapter "Setting the throttle cable"

If there is no higher speed, the tool is ready for operation.

At very low temperatures

- If necessary, convert engine to winter operation, see "Winter operation"
- If the power tool has cooled down considerably (frost formation), after starting let the engine warm up in the start position ▲ and bring it to operating temperature - Attention: the cutting attachment will rotate!

The engine does not fire

- Check whether all the controls are set correctly
- Check whether there is fuel in the tank and refuel if necessary
- Check whether the spark plug boot is connected securely
- Repeat the starting procedure

The engine is flooded

- Set choke lever to I – continue cranking until the engine runs

If the tank has been drained completely

- After refueling, press the manual fuel pump bulb at least five times – even if it is full of fuel.
- Restart the engine

Transporting the Unit

Using Transport Guard

The type of transport guard depends on the metal cutting attachment supplied with the machine. Transport guards are available as special accessories.

230 mm Grass Cutting Blades

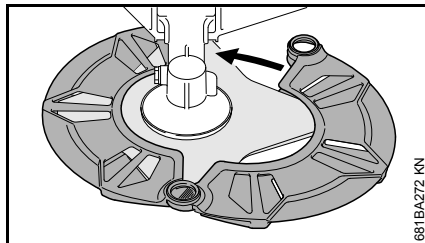
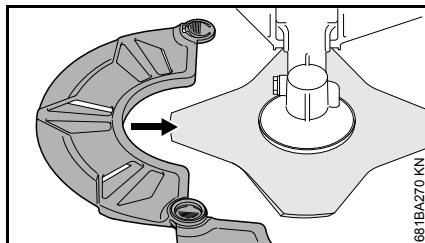
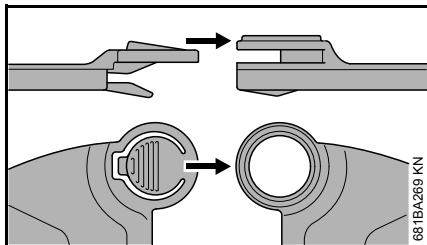
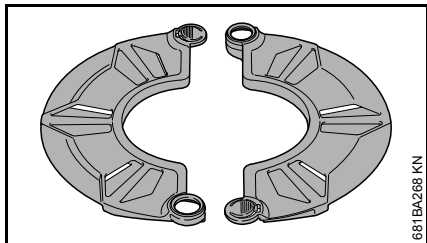

Grass Cutting Blades up to 260 mm

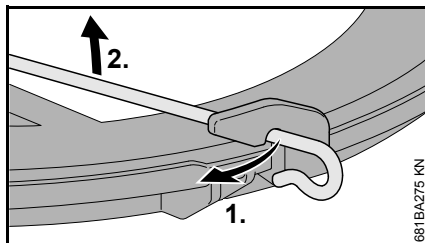
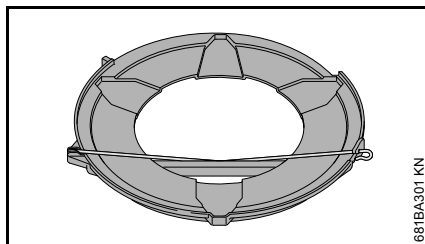

- Disconnect wire rod from the transport guard.

- Swing wire rod outwards.

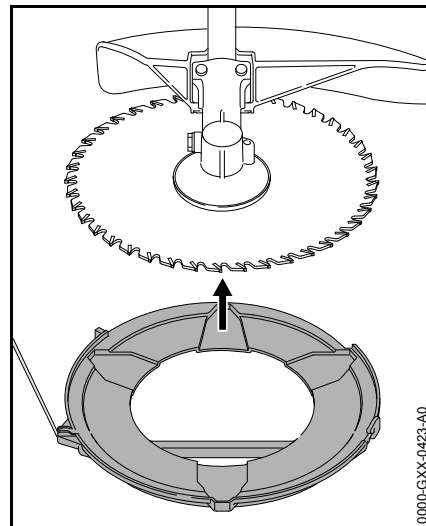

- Fit the transport guard on the cutting attachment from below.

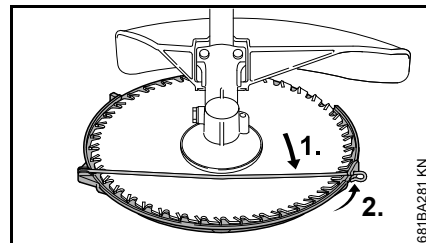

- Hook wire rod to the transport guard.
- Swing wire rod into position.

Circular Saw Blades

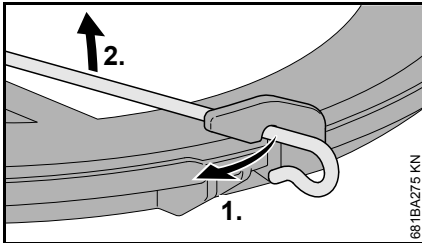
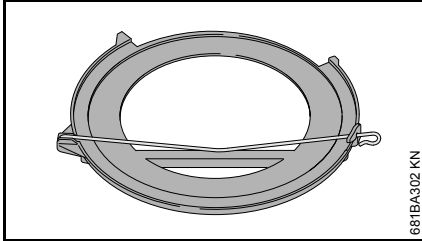

- Disconnect wire rod from the transport guard.

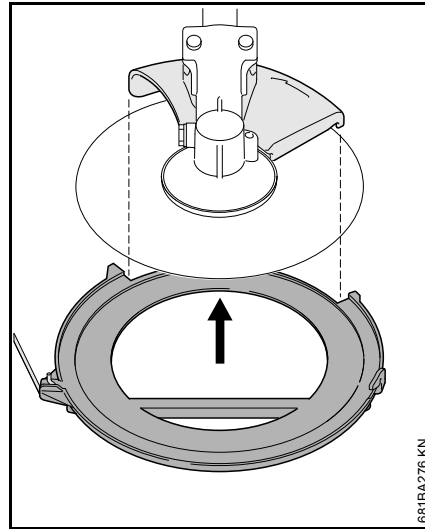

- Swing wire rod outwards.
- Fit transport guard on saw blade from below, making sure the limit stop is properly seated in the recess.

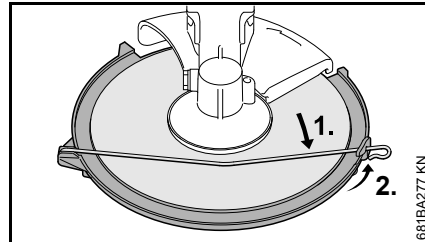

- Swing wire rod into position.
- Hook wire rod to the transport guard.

Universal Transport Guard

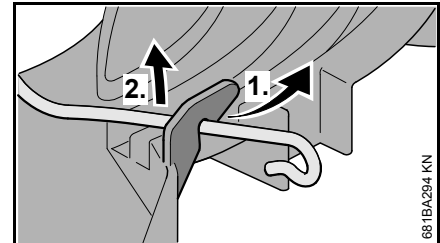
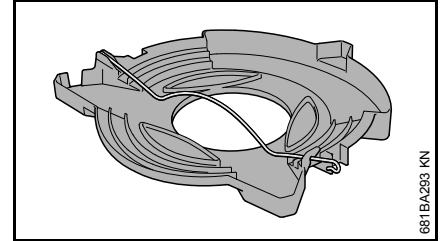

- Disconnect wire rod from the transport guard and swing it outwards.

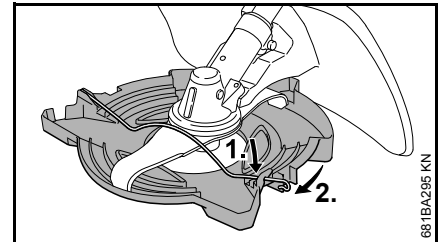

- Fit the transport guard on the cutting attachment from below.
- Attach wire rod to the hook on the transport guard.

Operating Instructions

During break-in period

A factory-new machine should not be run at high revs (full throttle off load) for the first three tank fillings. This avoids unnecessary high loads during the break-in period. As all moving parts have to bed in during the break-in period, the frictional resistances in the engine are greater during this period. The engine develops its maximum power after about 5 to 15 tank fillings.

During Operation

After a long period of full throttle operation, allow the engine to run for a short while at idle speed so that engine heat can be dissipated by the flow of cooling air. This protects engine-mounted components (ignition, carburetor) from thermal overload.

After Finishing Work

Storing for a short period: Wait for the engine to cool down. Empty the fuel tank and keep the machine in a dry place, well away from sources of ignition, until you need it again. For longer out-of-service periods – see "Storing the Machine".

Air filter

General Information

The filter has a very long service life.

Do not remove the filter cover or replace the air filter as long as there is no noticeable loss of power.

Dirty air filters reduce engine power, increase fuel consumption and make starting more difficult.

Replacing the Air Filter

Only if there is a noticeable loss of engine power

- Set the choke knob to ▲.

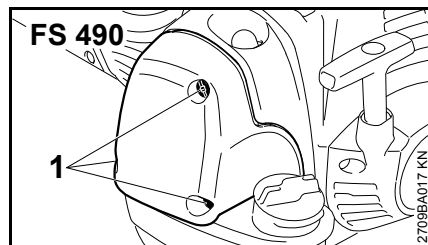
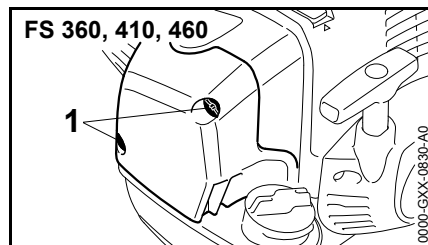

- Loosen the screws (1).

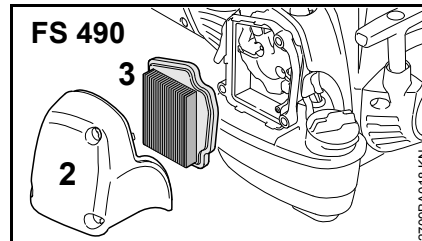
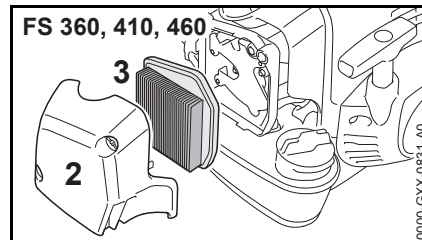

- Remove the filter cover (2).
- Clean away loose dirt from around the filter (3) and inside the filter cover.

The air filter (3) is a pleated paper filter element.

- Remove and check the filter element (3) – replace if paper or frame is dirty or damaged.
- Unpack the new filter.

NOTICE

Do not bend or twist the filter before installation as it might otherwise be damaged – do not use damaged filters.

- Fit the filter in the filter housing.
- Fit the filter cover.

Use only high quality air filters to ensure the engine is protected from abrasive dust.

STIHL recommends you use only original STIHL air filters. The high quality standard of these parts guarantees trouble-free operation, a long engine life and very long filter service lives.

Filter Element for Winter Operation

Maintenance and care of the special filter element for winter operation are described in the chapter on "Winter Operation".

M-Tronic

General Information

The M-Tronic controls fuel feed and ignition timing electronically in all operating conditions.

M-Tronic guarantees simple and fast starts. The engine is started in the Start ▲ position irrespective of climatic conditions or engine temperature. After starting, the Start ▲ position can be maintained until the engine runs smoothly.

M-Tronic ensures optimum engine power at all times, very good acceleration and automatic adjustment to suit changing conditions.

For this reason there is no need to change the carburetor setting – the carburetor has no adjusting screws.

If the usual good running behavior and engine power are not reached after an extreme change in operating conditions, contact your servicing dealer for assistance.

STIHL recommends that you have servicing and repair work carried out exclusively by an authorized STIHL servicing dealer.

Winter Operation

At temperatures below +10°C

Preheating the carburetor

Repositioning a shutter allows heated air to be drawn in from around the cylinder and mixed with cold air – this helps prevent carburetor icing.

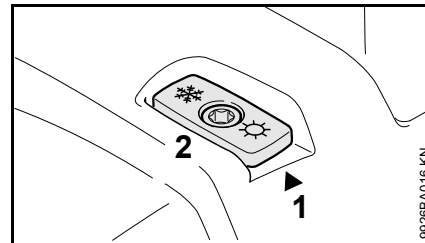

An arrow (1) on the shroud indicates the setting of the shutter (2) for summer or winter operation. Meaning of symbols:

- "Sun" = summer operation
- "Snowflake" = winter operation

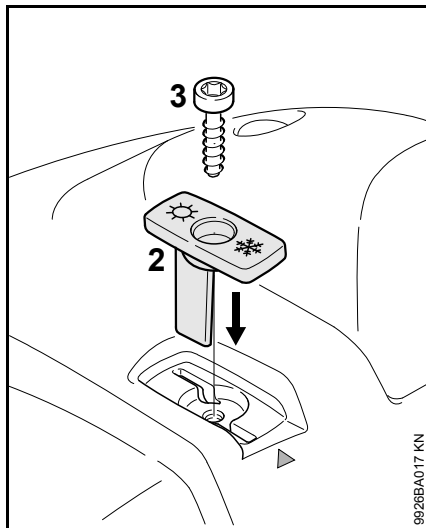

- Remove the screw (3) from the shutter.
- Pull the shutter (2) out of the shroud.
- Rotate the shutter (2) from the summer position to the winter position and refit it.
- Secure the shutter in position with the screw (3).

At temperatures between +10°C and +20°C

The machine can normally be operated in this temperature range with the shutter (2) in the summer position. Change the position of the shutter if necessary.

At temperatures above +20°C

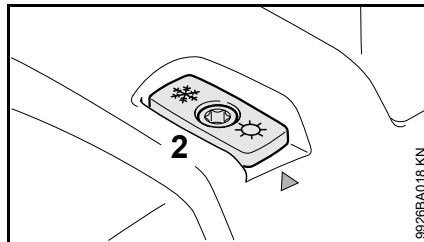

- Always return the shutter (2) to the summer position.



NOTICE

Do not operate the machine in the winter position at temperatures above +20°C because there is otherwise a risk of engine running problems and overheating.

At temperatures below -10°C

In extreme wintry conditions

- Temperatures below -10°C
- Powder or drifting snow

it is advisable to use the optional "cover plate kit".

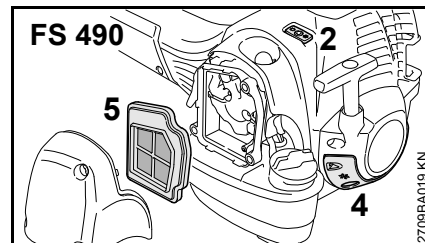
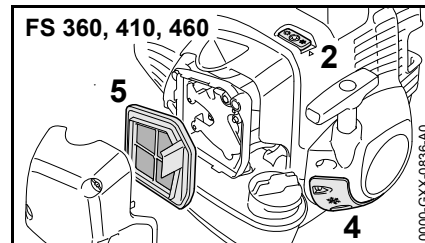

The cover plate kit contains the following parts for converting the power tool:

- 4 Cover plate partially blanks off the slots in the starter housing
- 5 Air filter with synthetic fabric element
- For FS 460 with tank cap with hinged grip: O-ring for the tank filler cap
- Instruction sheet describing the conversion.

After installing the cover plate kit:

- Set the shutter (2) to the winter position.

At temperatures above -10°C

- Remove the parts of the cover plate kit and refit the standard parts for summer operation.

Note for FS 460 with tank cap with hinged grip: The O-ring supplied with the cover plate kit can be left on the machine's filler cap.

Depending on the ambient temperature:

- Set the shutter (2) to the summer or winter position.

Clean the air filter.

- Loosen filter cover mounting screws.
- Remove the filter cover.
- Clean away loose dirt from around the filter (5) and inside the filter cover.
- Knock the filter (5) out on the palm of your hand or blow it clear with compressed air from the inside outwards.

In case of stubborn dirt or sticky filter fabric:

- Wash the filter in a clean, non-flammable solution (e.g. warm soapy water) and then dry.

Always replace a damaged filter.

Spark Plug

- If the engine is down on power, difficult to start or runs poorly at idle speed, first check the spark plug.
- Fit a new spark plug after about 100 operating hours – or sooner if the electrodes are badly eroded. Install only suppressed spark plugs of the type approved by STIHL – see "Specifications".

Removing the Spark Plug

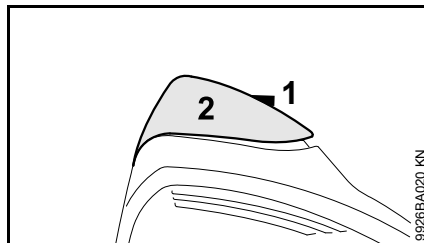

- Rotate the screw (1) in the cap (2) until the screw head projects from it.

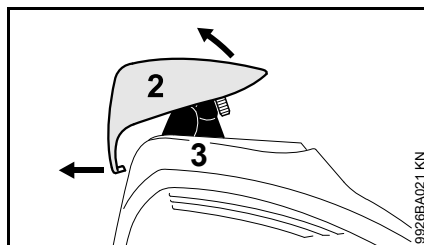

- Lift the front of the cap (2) and push it to the rear to disengage.
- Leave the cap to one side.
- Pull off the spark plug boot (3).
- Unscrew the spark plug.

Checking the Spark Plug

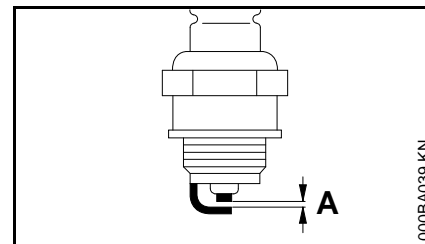

- Clean dirty spark plug.
- Check electrode gap (A) and readjust if necessary – see "Specifications".
- Rectify the problems which have caused fouling of the spark plug.

Possible causes are:

- Too much oil in fuel mix.
- Dirty air filter.
- Unfavorable running conditions.

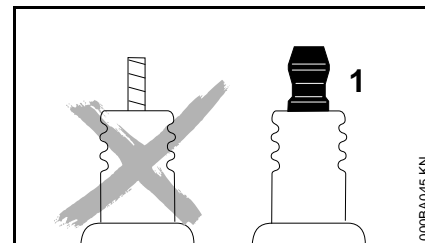

! WARNING

Arcing may occur if the adapter nut (1) is loose or missing. Working in an easily combustible or explosive atmosphere may cause a fire or an explosion. This can result in serious injuries or damage to property.

- Use resistor type spark plugs with a properly tightened adapter nut.

Installing the spark plug

- Screw in spark plug
- Firmly press the spark plug connector onto the spark plug.

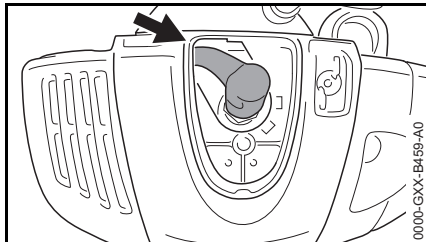

- Align the spark plug connector so that the ignition cable points to the upper left corner (arrow).

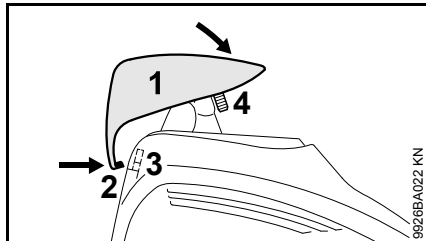

- Place the cap (1) on the hood from behind and at a slight angle, pressing the nose (2) into the opening (3) of the hood.
- On the front, swivel the cap onto the hood, screw in the screw (4) and tighten.

Engine Running Behavior

If engine running behavior is still unsatisfactory after servicing the air filter and adjusting the throttle cable, the cause may be the muffler.

Have the muffler checked by a servicing dealer for contamination (carbonization).

STIHL recommends that you have servicing and repair work carried out exclusively by an authorized STIHL servicing dealer.

Storing the Machine

If the machine is to remain out of use for approx. 3 months or more

- Drain and clean the fuel tank in a well ventilated place
- Dispose of fuel in accordance with the regulations and having regard for the environment
- Run the engine until the carburetor is dry. This helps to prevent the carburetor diaphragms sticking together.
- Remove, clean and inspect the cutting attachment. Treat metal cutting attachments with protective oil.
- Thoroughly clean the machine
- Store the machine in a dry and safe place, out of the reach of children and other unauthorized users

Sharpening Metal Cutting Blades

- Use a sharpening file (see "Special Accessories") to sharpen dull cutting attachments. In case of more serious wear or nicks: Resharpener with a grinder or have the work done by a dealer – STIHL recommends a STIHL servicing dealer.
- Sharpen frequently, take away as little metal as possible – two or three strokes of the file are usually enough.

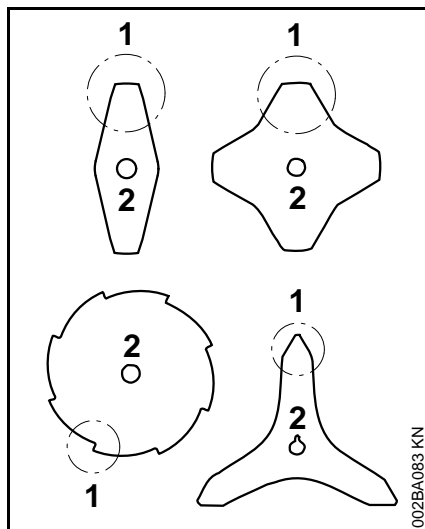

- Resharpener the teeth (1) uniformly – do not alter the contour of the parent blade (2) in any way.

See cutting attachment packaging for additional sharpening instructions. Keep the packaging for future reference.

Balancing

- After resharpening about 5 times, check the cutting attachment for out-of-balance on a STIHL balancer – see "Special Accessories" – or have it checked by a dealer and re-balanced as necessary – STIHL recommends a STIHL servicing dealer.

Maintaining the Mowing Head

Placing power tool on the ground

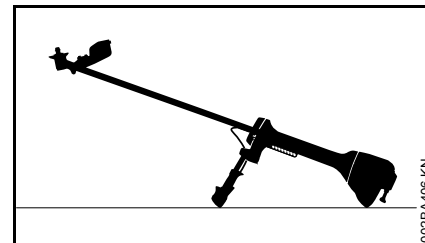

- Shut off the engine.
- Lay your power tool on its back so that the cutting attachment mounting face is pointing up.

Replacing Nylon Line

Always check the mowing head for signs of wear before replacing the nylon line.

! WARNING

If there are signs of serious wear, replace the complete mowing head.

The nylon mowing line is referred to as "nylon line" or "line" in the following.

The mowing head is supplied with illustrated instructions for replacing the nylon line. Keep the instructions for the mowing head in a safe place.

- If necessary, remove the mowing head.

Adjusting Nylon Line

STIHL SuperCut

Fresh line is advanced automatically if the remaining line is **at least 6 cm (2 1/2 in)** long. The blade on the deflector trims overlong lines to the correct length.

STIHL AutoCut

- With the engine running, hold the rotating mowing head above the grass surface.
- Tap it on the ground once – fresh line is advanced and the blade on the deflector trims it to the right length.

Fresh line is advanced every time the mowing head is tapped on the ground. For this reason observe the mowing head's cutting performance during operation. If the mowing head is tapped on the ground too often, the line limiting blade will unnecessarily cut off unused lengths of nylon line.

Line feed operates only if both lines are still at least **2.5 cm (1 in)** long.

STIHL TrimCut



WARNING

To reduce the risk of injury, always shut off the engine before adjusting the nylon line by hand.

- Pull the spool up – rotate it about 1/6 turn counterclockwise until it engages – and allow it to spring back.
- Pull ends of the lines outward.

Repeat the above procedure as necessary until both lines reach the limiter blade on the deflector.

Rotating the spool from one stop to the next advances about **4 cm (1 1/2 in)** of fresh line.

Replacing Nylon Line

STIHL PolyCut

Precut lengths of nylon line can be fitted to the PolyCut in place of the cutting blades.

STIHL DuroCut, STIHL PolyCut



WARNING

To reduce the risk of injury, always shut off the engine before refilling the mowing head.

- Fit precut lengths of nylon line in the mowing head as described in the instructions supplied.

Replacing Cutting Blades

STIHL PolyCut

Always check the mowing head for signs of wear before installing new cutting blades.



WARNING

If there are signs of serious wear, replace the complete mowing head.

The thermoplastic cutting blades are referred to as "blades" in the following.

The mowing head is supplied with illustrated instructions for replacing the blades. Keep the instructions for the mowing head in a safe place.



WARNING

To reduce the risk of injury, always shut off the engine before installing the blades.

- Remove the mowing head.
- Replace blades as shown in the illustrated instructions.
- Mount the mowing head on the machine.

Inspection and Maintenance by User

Clamped Area of Handlebar

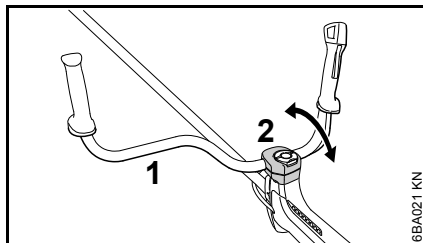

- Check the freedom of movement of the handlebar (1) in the clamp moldings (2) at regular intervals.

Handlebar is difficult to move

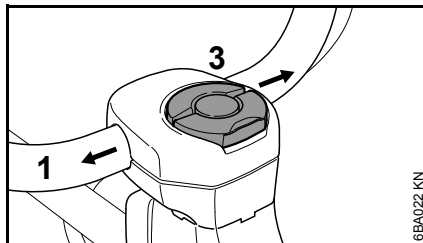

- Loosen the wing screw (3) just enough for the handlebar to be moved.
- Push the handlebar (1) sideways out of the clamp.
- Soak a cloth in a clean, non-flammable cleaning solution – do not use a cleaning agent containing oil or grease.

- Thoroughly clean the clamp area of the handlebar with the cloth and cleaning solution.
- Line up the handlebar and secure it in position with the wing screw.

Handlebar cannot be clamped firmly in position

- Release handlebar in clamp as described under "Handlebar is difficult to move".
- Degrease clamp area on handlebar and in clamp moldings.
- Line up the handlebar and secure it in position with the wing screw.

Inspections and Maintenance by Dealer

Maintenance Work

STIHL recommends that you have servicing and repair work carried out exclusively by an authorized STIHL servicing dealer.

Fuel Pickup Body in Tank

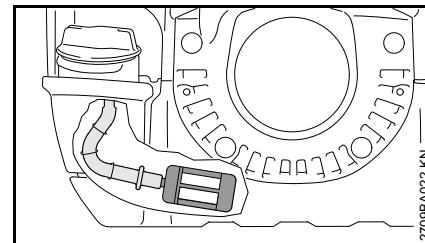

- Check the pickup body in the fuel tank every year and have it replaced if necessary.

The pickup body should be positioned in the area of the tank shown in the illustration.

Anti-vibration elements

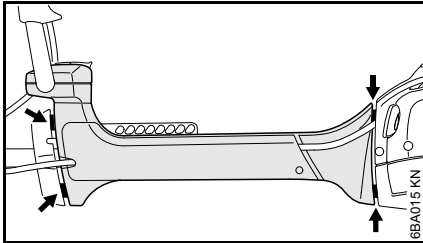

Four anti-vibration elements (arrows) are installed between the powerhead and the drive tube. Have the system checked if there is a noticeable increase in vibrations.

Both vibration gaps (arrows) are preset to the same width at the factory. If the size of the two vibration gaps varies greatly and/or one of them closes up, have your servicing dealer repair the anti-vibration system.

Wear Guard on AV Housing

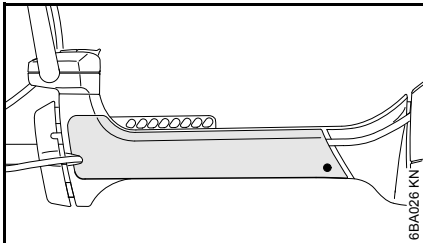

There is an easily replaced wear guard on the side of the anti-vibration housing. The guard may wear as a result of rubbing against the side plate of the harness during operation and should be replaced if necessary.

Maintenance and Care

The following intervals apply for normal operating conditions. The specified intervals must be shortened accordingly when working for longer than normal or under difficult cutting conditions (extensive dust, etc.).		Before starting work	At the end of work and/or daily	Whenever tank is refilled	Weekly	Monthly	Annually	If faulty	If damaged	As required
Complete machine	Visual inspection (safe condition, leaks)	X		X						
	Clean		X							
	Replace any damaged parts	X								
Control handle	Function test	X		X						
Air filter, paper filter	Visual inspection					X		X		
	Replace ¹⁾								X	
Air filter, plastic fabric filter	Visual inspection					X		X		
	Clean									X
	replace								X	X
Fuel tank	Clean									X
Manual fuel pump (if present)	check	X								
	Have repaired by a specialist dealer ²⁾								X	
Fuel pickup body in fuel tank	Check ²⁾							X		
	Replace ²⁾						X		X	X
Engine idle speed	Check, cutting attachment must not turn	X		X						
	If the cutting attachment turns when the engine is idling, have machine repaired by servicing dealer ²⁾									X
Spark plug	Adjust electrode gap							X		
	Replace after every 100 hours of operation									
Cooling air intakes	Visual inspection		X							
	Clean									X
Cylinder fins	Clean ²⁾						X			

The following intervals apply for normal operating conditions. The specified intervals must be shortened accordingly when working for longer than normal or under difficult cutting conditions (extensive dust, etc.).		Before starting work	At the end of work and/or daily	Whenever tank is refilled	Weekly	Monthly	Annually	If faulty	If damaged	As required
Spark arrestor ³⁾ in muffler	Check ²⁾							X		
	Clean or replace if necessary ²⁾								X	
All accessible screws, nuts and bolts (not adjusting screws) ⁴⁾	Tighten									X
Anti-vibration elements	Visual inspection ⁵⁾	X						X		
	Replace ²⁾								X	
Cutting attachment	Visual inspection	X		X						
	replace								X	
	Check for secure fit	X		X						
Metal cutting attachment	sharpen	X								X
Safety information label	replace								X	

1) Only if there is a noticeable loss of engine power

2) STIHL recommends that this work be done by a STIHL servicing dealer

3) present only in some countries

4) Tighten the screws for the muffler after a running time of 10 to 20 hours after commissioning

5) see chapter "Inspection and Maintenance by Dealer", section "Antivibration Elements"

Minimize Wear and Avoid Damage

Observing the instructions in this manual helps reduce the risk of unnecessary wear and damage to the power tool.

The power tool must be operated, maintained and stored with the due care and attention described in this owner's manual.

The user is responsible for all damage caused by non-observance of the safety precautions, operating and maintenance instructions in this manual. This includes in particular:

- Alterations or modifications to the product not approved by STIHL.
- Using tools or accessories which are neither approved or suitable for the product or are of a poor quality.
- Using the product for purposes for which it was not designed.
- Using the product for sports or competitive events.
- Consequential damage caused by continuing to use the product with defective components.

Maintenance Work

All the operations described in the "Maintenance Chart" must be performed on a regular basis. If these maintenance operations cannot be performed by the owner, they should be performed by a servicing dealer.

STIHL recommends that you have servicing and repair work carried out exclusively by an authorized STIHL

servicing dealer. STIHL dealers are regularly given the opportunity to attend training courses and are supplied with the necessary technical information.

If these maintenance operations are not carried out as specified, the user assumes responsibility for any damage that may occur. Among other parts, this includes:

- Damage to the engine due to neglect or deficient maintenance (e.g. air and fuel filters), incorrect carburetor adjustment or inadequate cleaning of cooling air inlets (intake ports, cylinder fins).
- Corrosion and other consequential damage resulting from improper storage.
- Damage to the machine resulting from the use of poor quality replacement parts.

Parts Subject to Wear and Tear

Some parts of the power tool are subject to normal wear and tear even during regular operation in accordance with instructions and, depending on the type and duration of use, have to be replaced in good time. Among other parts, this includes:

- Cutting attachments (all types)
- Mounting hardware for cutting attachments (rider plate, nut, etc.)
- Deflectors for cutting attachments
- Clutch
- Filters (air, fuel)
- Rewind starter

- Throttle cable
- Spark plug
- Antivibration elements
- Wear guard on antivibration housing

Main Parts

FS 360, 410, 460

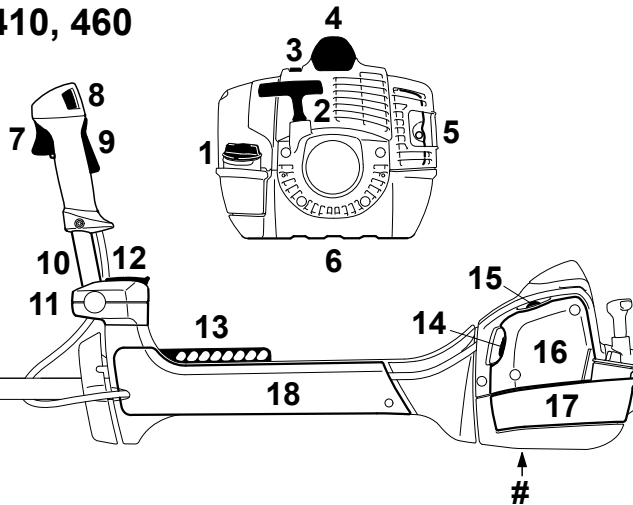

FS 490

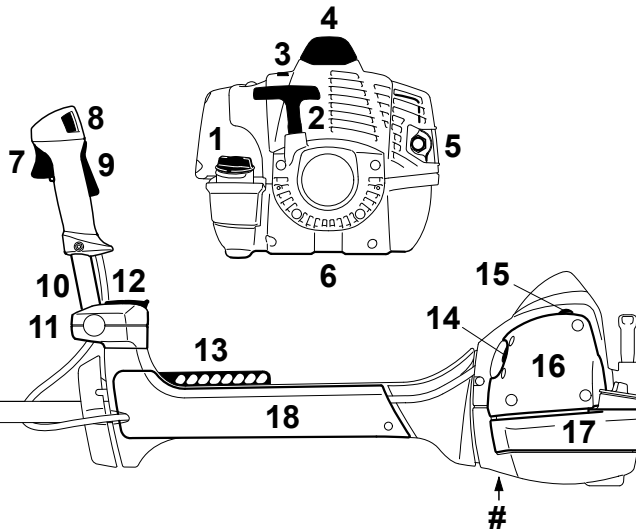

- 1 Tank cap
- 2 Starter grip
- 3 Shutter (winter operation)
- 4 Spark plug boot
- 5 Muffler
- 6 Guard plate
- 7 Throttle trigger
- 8 Stop switch
- 9 Throttle trigger lockout
- 10 Handlebar
- 11 Handle support
- 12 Wing screw
- 13 Carrying strip
- 14 Choke lever
- 15 Manual fuel pump
- 16 Filter cover
- 17 Fuel tank
- 18 Wear guard
- # Serial number

0000-G3X-0835-A0

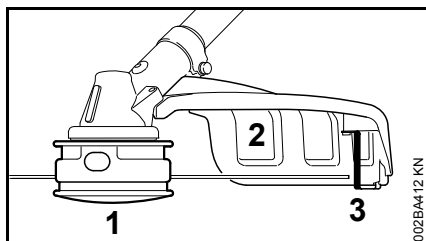

- 1 Mowing head
- 2 Deflector for mowing heads only
- 3 Blade

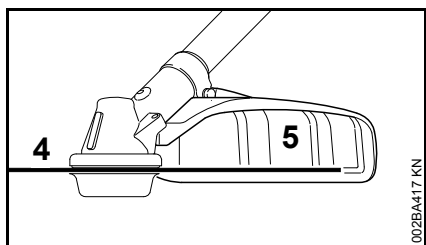

- 4 Metal mowing attachment
- 5 Deflector (for metal mowing attachments only)

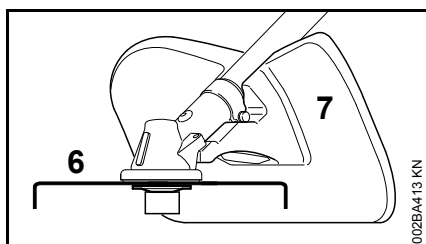

- 6 Shredder blade
- 7 Shredder deflector (only for shredding with shredder blades)

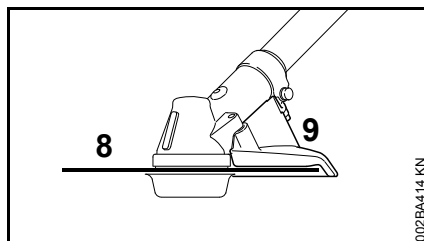

- 8 Circular Saw Blade
- 9 Limit stop (for circular saw blades only)

Specifications

Engine

Single cylinder two-stroke engine

FS 360 C

Displacement:	37.7 cc
Bore:	40 mm
Stroke:	30 mm
Engine power to ISO 8893:	1.7 kW (2.3 bhp) at 8,500 rpm
Idle speed:	2,700 rpm
Cut-off speed (rated):	12,300 rpm

Max. output shaft speed (cutting attachment): 8,870 rpm

FS 410 C

Displacement:	41.6 cc
Bore:	42 mm
Stroke:	30 mm
Engine power to ISO 8893:	2.0 kW (2.7 bhp) at 9,000 rpm
Idle speed:	2,700 rpm
Cut-off speed (rated):	12,300 rpm

Max. output shaft speed (cutting attachment): 8,870 rpm

FS 460 C

Displacement:	45.6 cc
Bore:	44 mm
Stroke:	30 mm
Engine power to ISO 8893:	2.2 kW (3 bhp) at 9,500 rpm

English

Idle speed:	2,700 rpm
Cut-off speed (rated):	12,300 rpm
Max. output shaft speed (cutting attachment):	8,870 rpm

FS 490 C

Displacement:	51.6 cc
Bore:	44.7 mm
Stroke:	32.9 mm
Engine power to ISO 8893:	2.4 kW (3.3 bhp) at 9,500 rpm
Idle speed:	2,500 rpm
Cut-off speed (rated):	12,300 rpm
Max. output shaft speed (cutting attachment):	8,870 rpm

Ignition System

Electronic magneto ignition

FS 360 C, FS 410 C, FS 460 C

Spark plug (resistor type):	NGK CMR6H Bosch USR4AC
Electrode gap:	0.5 mm

FS 490 C

Spark plug (resistor type):	NGK BPMR7A
Electrode gap:	0.5 mm

Fuel System

All position diaphragm carburetor with integral fuel pump

Fuel tank capacity:	
FS 360 C:	750 cc (0.75 l)

FS 410 C:	750 cc (0.75 l)
FS 460 C:	750 cc (0.75 l)
FS 490 C:	990 cc (0.99 l)

Weight

Dry, without cutting attachment and deflector

FS 360 C-EM:	8.5 kg
FS 410 C-EM:	8.5 kg
FS 410 C-EM L:	8.6 kg
FS 460 C-EM:	8.5 kg
FS 460 C-EM L:	8.6 kg
FS 490 C-EM:	9.1 kg
FS 490 C-EM L:	9.2 kg

Overall length

without cutting attachment

FS 360 C-EM:	1790 mm
FS 410 C-EM:	1790 mm
FS 410 C-EM L:	1850 mm
FS 460 C-EM:	1790 mm
FS 460 C-EM L:	1850 mm
FS 490 C-EM:	1795 mm
FS 490 C-EM L:	1855 mm

Features

C	Convenience features
E	ErgoStart
M	M-Tronic
L	Long drive tube
Z	Spark arresting screen

Noise and Vibration Data

Noise and vibration data measurements on FS units include idling and rated maximum speed with the same duration of exposure.

For further details on compliance with Vibration Directive 2002/44/EC see www.stihl.com/vib.

Sound pressure level L_p to ISO 22868

with mowing head

FS 360 C-EM:	99 dB(A)
FS 410 C-EM:	101 dB(A)
FS 410 C-EM L:	101 dB(A)
FS 460 C-EM:	101 dB(A)
FS 460 C-EM L:	101 dB(A)
FS 490 C-EM:	102 dB(A)
FS 490 C-EM L:	102 dB(A)

with metal mowing attachment

FS 360 C-EM:	98 dB(A)
FS 410 C-EM:	99 dB(A)
FS 410 C-EM L:	99 dB(A)
FS 460 C-EM:	100 dB(A)
FS 460 C-EM L:	100 dB(A)
FS 490 C-EM:	102 dB(A)
FS 490 C-EM L:	102 dB(A)

Sound power level L_w to ISO 22868

with mowing head

FS 360 C-EM:	112 dB(A)
FS 410 C-EM:	113 dB(A)
FS 410 C-EM L:	113 dB(A)
FS 460 C-EM:	110 dB(A)
FS 460 C-EM L:	110 dB(A)
FS 490 C-EM:	112 dB(A)

FS 490 C-EM L: with metal mowing attachment	112 dB(A)
FS 360 C-EM:	110 dB(A)
FS 410 C-EM:	112 dB(A)
FS 410 C-EM L:	112 dB(A)
FS 460 C-EM:	110 dB(A)
FS 460 C-EM L:	110 dB(A)
FS 490 C-EM:	113 dB(A)
FS 490 C-EM L:	113 dB(A)

Vibration measurement $a_{hv,eq}$ to ISO 22867

	Handle, left	Handle, right
with mowing head		
FS 360 C-EM:	2.5 m/s ²	2.2 m/s ²
FS 410 C-EM:	2.4 m/s ²	2.3 m/s ²
FS 410 C-EM L:	2.4 m/s ²	2.3 m/s ²
FS 460 C-EM:	2.5 m/s ²	2.1 m/s ²
FS 460 C-EM L:	2.1 m/s ²	2.3 m/s ²
FS 490 C-EM:	3.7 m/s ²	3.7 m/s ²
FS 490 C-EM L:	3.7 m/s ²	3.7 m/s ²
with metal mow- ing attachment	Handle, left	Handle, right
FS 360 C-EM:	2.2 m/s ²	2.0 m/s ²
FS 410 C-EM:	2.3 m/s ²	2.0 m/s ²
FS 410 C-EM L:	2.3 m/s ²	2.0 m/s ²
FS 460 C-EM:	1.9 m/s ²	1.6 m/s ²
FS 460 C-EM L:	1.9 m/s ²	1.6 m/s ²
FS 490 C-EM:	2.8 m/s ²	2.8 m/s ²
FS 490 C-EM L:	2.8 m/s ²	2.8 m/s ²

The K-factor in accordance with Directive 2006/42/EC is 2.0 dB(A) for the sound pressure level and sound power level; the K-factor in accordance with Directive 2006/42/EC is 2.0 m/s² for the vibration level.

FS 360 C-M, FS 410 C-M, FS 460 C-M, FS 490 C-M

REACH

REACH is an EC regulation and stands for the Registration, Evaluation, Authorisation and Restriction of Chemical substances.

For information on compliance with the REACH regulation (EC) No. 1907/2006 see www.stihl.com/reach.

Exhaust Emissions

The CO₂ value measured in the EU type approval procedure is specified at www.stihl.com/co2.

The measured CO₂ value was determined on a representative engine in accordance with a standardized test procedure under laboratory conditions and does not represent either an explicit or implied guarantee of the performance of a specific engine.

The applicable exhaust emission requirements are fulfilled by the intended usage and maintenance described in this instruction manual. The type approval expires if the engine is modified in any way.

Maintenance and Repairs

Users of this machine may only carry out the maintenance and service work described in this user manual. All other repairs must be carried out by a servicing dealer.

STIHL recommends that you have servicing and repair work carried out exclusively by an authorized STIHL servicing dealer. STIHL dealers are regularly given the opportunity to attend training courses and are supplied with the necessary technical information.

When repairing the machine, only use replacement parts which have been approved by STIHL for this power tool or are technically identical. Only use high-quality replacement parts in order to avoid the risk of accidents and damage to the machine.

STIHL recommends the use of original STIHL replacement parts.

Original STIHL parts can be identified by the STIHL part number, the **STIHL** logo and the STIHL parts symbol  (the symbol may appear alone on small parts).

Disposal

Observe all country-specific waste disposal rules and regulations.

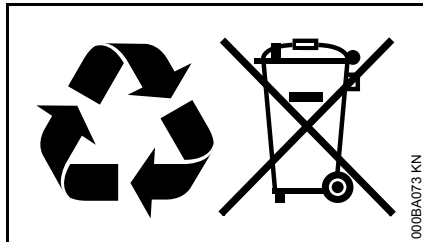

STIHL products must not be thrown in the garbage can. Take the product, accessories and packaging to an approved disposal site for environment-friendly recycling.

Contact your STIHL servicing dealer for the latest information on waste disposal.

EC Declaration of Conformity

ANDREAS STIHL AG & Co. KG
Badstr. 115
D-71336 Waiblingen

Germany

declare under our sole responsibility that

Designation:	Clearing Saws
Make:	STIHL
Series:	FS 360 C-EM FS 410 C-EM FS 410 C-EM L FS 460 C-EM FS 460 C-EM L

Serial identification number:	4147 FS 490 C-EM FS 490 C-EM L
-------------------------------	--------------------------------------

Serial identification number:	4148
-------------------------------	------

Displacement	
FS 360 C-EM	37 cm ³
FS 410 C-EM	41.6 cm ³
FS 410 C-EM L	41.6 cm ³
FS 460 C-EM	45.6 cm ³
FS 460 C-EM L	45.6 cm ³
FS 490 C-EM	51.6 cm ³
FS 490 C-EM L	51.6 cm ³

conforms to the relevant provisions of Directives 2011/65/EU, 2006/42/EC, 2014/30/EU and 2000/14/EC and has been developed and manufactured in compliance with the following standards in the versions valid on the date of production:

EN ISO 11806-1, EN 55012,
EN 61000-6-1

The measured and the guaranteed sound power level have been determined in accordance with Directive 2000/14/EC, Annex V, and standard ISO 10884.

Measured sound power level

FS 360 C-EM:	112 dB(A)
FS 410 C-EM:	113 dB(A)
FS 410 C-EM L:	113 dB(A)
FS 460 C-EM:	114 dB(A)
FS 460 C-EM L:	114 dB(A)
FS 490 C-EM:	116 dB(A)
FS 490 C-EM L:	116 dB(A)

Guaranteed sound power level

FS 360 C-EM:	114 dB(A)
FS 410 C-EM:	115 dB(A)
FS 410 C-EM L:	115 dB(A)
FS 460 C-EM:	116 dB(A)
FS 460 C-EM L:	116 dB(A)
FS 490 C-EM:	118 dB(A)
FS 490 C-EM L:	118 dB(A)

Technical documents deposited at:

ANDREAS STIHL AG & Co. KG
Produktzulassung

The year of manufacture and serial number are applied to the product.

Done at Waiblingen, 15.07.2021
ANDREAS STIHL AG & Co. KG

pp

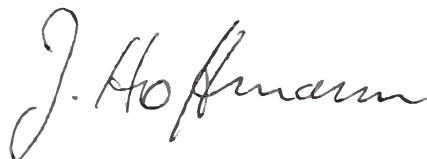

Dr. Jürgen Hoffmann
Director Product Certification &
Regulatory Affairs



UKCA Declaration of Conformity

ANDREAS STIHL AG & Co. KG
Badstr. 115
D-71336 Waiblingen
Germany

declare under our sole responsibility that

Designation:	Clearing Saws
Make:	STIHL
Series:	FS 360 C-EM FS 410 C-EM FS 410 C-EM L FS 460 C-EM FS 460 C-EM L

Serial identification number:	4147 FS 490 C-EM FS 490 C-EM L
-------------------------------	--------------------------------------

Serial identification number:	4148
Displacement	
FS 360 C-EM	37 cm ³
FS 410 C-EM	41.6 cm ³
FS 410 C-EM L	41.6 cm ³
FS 460 C-EM	45.6 cm ³
FS 460 C-EM L	45.6 cm ³
FS 490 C-EM	51.6 cm ³
FS 490 C-EM L	51.6 cm ³

conforms to the relevant provisions of UK regulations The Restriction of the Use of Certain Hazardous Substances in Electrical and Electronic Equipment Regulations 2012, Supply of Machinery (Safety) Regulations 2008, Electromagnetic Compatibility Regulations 2016 and Noise Emission in

the Environment by Equipment for use Outdoors Regulations 2001 and has been manufactured in compliance with the following standards in the versions valid on the date of production:

EN ISO 11806-1, EN 55012,
EN 61000-6-1

The measured and guaranteed sound power levels were determined in accordance with the UK regulation Noise Emission in the Environment by Equipment for use Outdoors Regulations 2001, Schedule 8, using the ISO 10884 standard.

Measured sound power level

FS 360 C-EM:	112 dB(A)
FS 410 C-EM:	113 dB(A)
FS 410 C-EM L:	113 dB(A)
FS 460 C-EM:	114 dB(A)
FS 460 C-EM L:	114 dB(A)
FS 490 C-EM:	116 dB(A)
FS 490 C-EM L:	116 dB(A)

Guaranteed sound power level

FS 360 C-EM:	114 dB(A)
FS 410 C-EM:	115 dB(A)
FS 410 C-EM L:	115 dB(A)
FS 460 C-EM:	116 dB(A)
FS 460 C-EM L:	116 dB(A)
FS 490 C-EM:	118 dB(A)
FS 490 C-EM L:	118 dB(A)

Technical documents deposited at:
ANDREAS STIHL AG & Co. KG

The year of manufacture and serial number are indicated on the product.

English

Done at Waiblingen, 15.07.2021

ANDREAS STIHL AG & Co. KG

pp

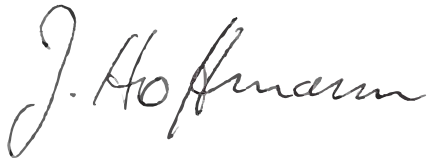
A handwritten signature in black ink, reading "J. Hoffmann". The signature is written in a cursive style with a large initial "J" and a long, sweeping underline.

Dr. Jürgen Hoffmann

Director Product Certification &
Regulatory Affairs

The UKCA logo, consisting of the letters "UK" stacked above "CA" in a bold, black, sans-serif font.

0458-746-0121-E

englisch



www.stihl.com



0458-746-0121-E